

Integration

Programming

IPv6

Applications

IPv6 Courses

©G6 Association

November 18, 2015

Integration

Programming
IPv6
Applications

1 Integration

2 Programming IPv6 Applications

Integration

Why IPv6 Integration ?

Integration

Why IPv6 Integration ?

6 generic
scenarios
Tools overview
Scenarios
Backbone
operator
Internet Access
Provider
3G/LTE
Enterprise
Home network
and SOHO

Programming
IPv6
Applications

IPv4 address space depletion

- IANA pool already depleted (Feb. 2011)
- Most RIR pool depleted too (2011-2015, except for AfriNIC)
- LIRs' pools will be depleted later. . .
- New companies will not be able to get IPv4 address space
- Existing companies will not be able to extend theirs

Complexity increasing in the IPv4 world (networks & services):

- Lack/absence of routable IPv4 addresses
- NAT violates the "end-to-end" principle, multiple-level NATs coming (NAT444)!
- Even private space ([RFC 1918](#)) is not enough for some networks (example: Comcast would need 100 M+ @ to address their subscribers' set-top boxes)
- NAT Traversal development cost is getting unbearable

Integration

Why IPv6

Integration ?

6 generic scenarios

Tools overview

Scenarios

Backbone operator

Internet Access Provider

3G/LTE

Enterprise

Home network and SOHO

Programming

IPv6

Applications

- IPv4 and IPv6 are incompatible
 - Different packet format
 - Prefixes are different
- No backward compatibility, but management is very similar.
- IETF planned to deploy IPv6 then make IPv4 disappeared
 - but Metcalf's law was on IPv4 side.
 - Content on IPv4, so few actors moved.
 - Not a complete chain so access is difficult.
- Some Integration mechanisms are dangerous

Integration

Why IPv6

Integration ?

6 generic scenarios

Tools overview

Scenarios

Backbone operator

Internet Access Provider

3G/LTE

Enterprise

Home network and SOHO

Programming

IPv6

Applications

- OSES have integrated IPv6
 - Window 7, iOS, Linux,...
- Some applications are compatible with IPv6
 - see  http://en.wikipedia.org/wiki/Comparison_of_IPv6_application_support
- Routers have integrated IPv6
 - Cisco, Juniper, ALU,...
- but the chain is not complete, so IPv6 is not fully available
- An address is not only used to forward packet
 - Allocation procedures
 - Management (size is different)
 - ...
- IPv6 is new. Test products before production!

Integration

6 generic scenarios

Who initiates communication towards whom (6 possibilities)?

- 1 An IPv4 system connects to an IPv4 system through an IPv4 network
- 2 An IPv6 system connects to an IPv6 system through an IPv6 network
- 3 An IPv4 system connects to an IPv4 system through an IPv6 network
- 4 An IPv6 system connects to an IPv6 system through an IPv4 network
- 5 An IPv4 system connects to an IPv6 system
- 6 An IPv6 system connects to an IPv4 system

Complexity

- 1) & 2) : Quite obvious
- 3) & 4) : Less easy but no real problem
- 5) & 6) : Quite complex. There is no global solution today (different partial solutions following different approaches)

An IPv4 system connects to an IPv4 system through an IPv4 network

Integration

Why IPv6

Integration ?

6 generic scenarios

Tools overview

Scenarios

Backbone operator

Internet Access Provider

3G/LTE

Enterprise

Home network and SOHO

Programming

IPv6

Applications

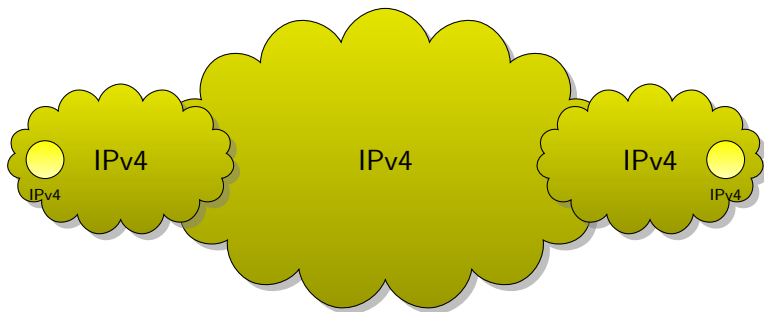

An IPv4 system connects to an IPv4 system through an IPv4 network

Integration

Why IPv6

Integration ?

6 generic scenarios

Tools overview

Scenarios

Backbone operator

Internet Access Provider

3G/LTE

Enterprise

Home network and SOHO

Programming

IPv6

Applications



An IPv4 system connects to an IPv4 system through an IPv4 network

Integration

Why IPv6

Integration ?

6 generic scenarios

Tools overview

Scenarios

Backbone operator

Internet Access Provider

3G/LTE

Enterprise

Home network and SOHO

Programming

IPv6

Applications



An IPv6 system connects to an IPv6 system through an IPv6 network

Integration

Why IPv6

Integration ?

6 generic scenarios

Tools overview

Scenarios

Backbone operator

Internet Access Provider

3G/LTE

Enterprise

Home network and SOHO

Programming

IPv6

Applications

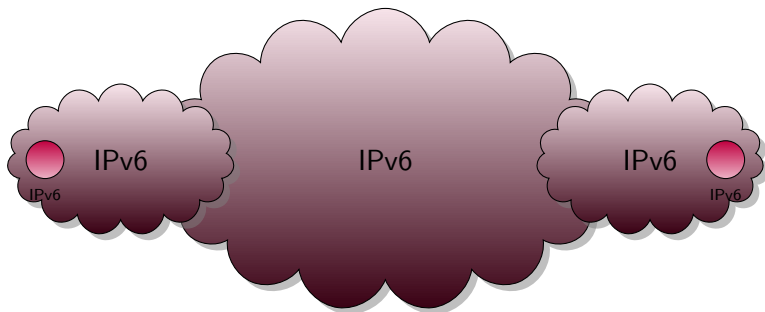

An IPv6 system connects to an IPv6 system through an IPv6 network

Integration

Why IPv6

Integration ?

6 generic scenarios

Tools overview

Scenarios

Backbone operator

Internet Access Provider

3G/LTE

Enterprise

Home network and SOHO

Programming

IPv6

Applications



An IPv6 system connects to an IPv6 system through an IPv6 network

Integration

Why IPv6

Integration ?

6 generic scenarios

Tools overview

Scenarios

Backbone operator

Internet Access Provider

3G/LTE

Enterprise

Home network and SOHO

Programming

IPv6

Applications

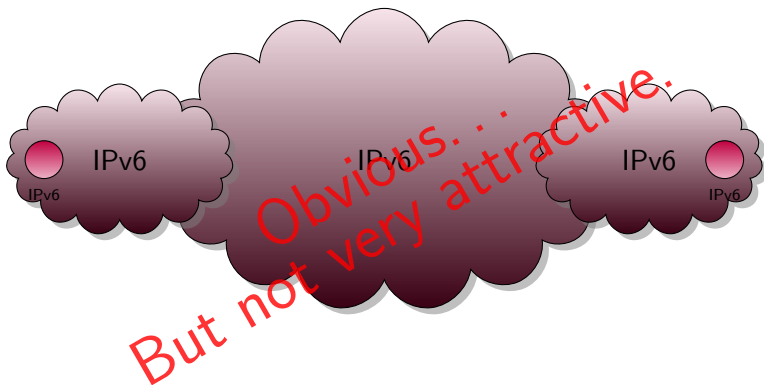

An IPv4 system connects to an IPv4 system through an IPv6 network

Integration

Why IPv6

Integration ?

6 generic scenarios

Tools overview

Scenarios

Backbone operator

Internet Access Provider

3G/LTE

Enterprise

Home network and SOHO

Programming

IPv6

Applications

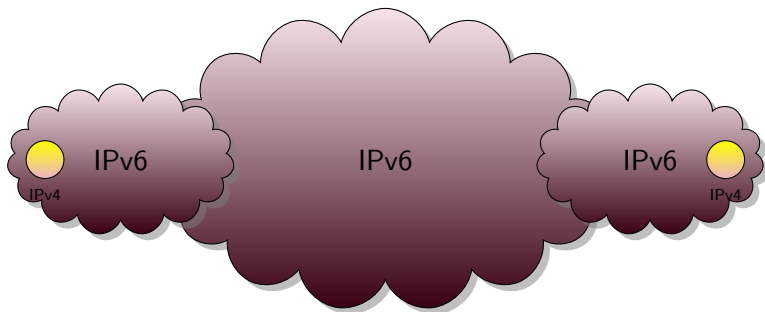

An IPv4 system connects to an IPv4 system through an IPv6 network

Integration

Why IPv6

Integration ?

6 generic scenarios

Tools overview

Scenarios

Backbone operator

Internet Access Provider

3G/LTE

Enterprise

Home network and SOHO

Programming

IPv6

Applications

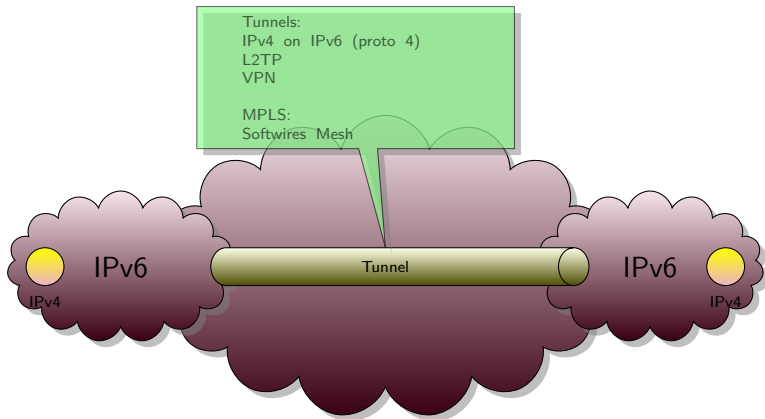

An IPv4 system connects to an IPv4 system through an IPv6 network

Integration

Why IPv6

Integration ?

6 generic scenarios

Tools overview

Scenarios

Backbone operator

Internet Access Provider

3G/LTE

Enterprise

Home network and SOHO

Programming

IPv6

Applications

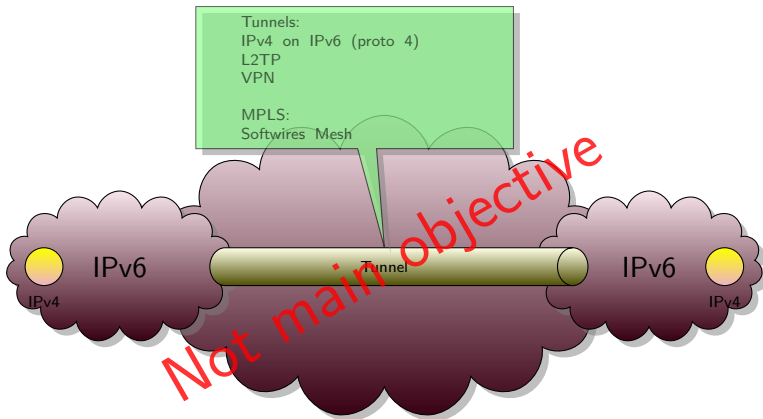

An IPv6 system connects to an IPv6 system through an IPv4 network

Integration

Why IPv6

Integration ?

6 generic scenarios

Tools overview

Scenarios

Backbone operator

Internet Access Provider

3G/LTE

Enterprise

Home network and SOHO

Programming

IPv6

Applications

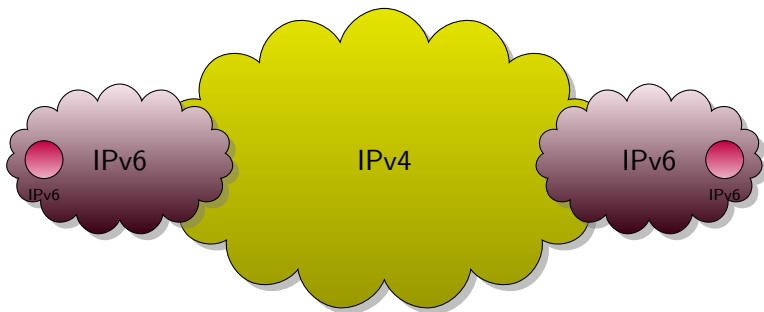

An IPv6 system connects to an IPv6 system through an IPv4 network

Integration

Why IPv6

Integration ?

6 generic scenarios

Tools overview

Scenarios

Backbone operator

Internet Access Provider

3G/LTE

Enterprise

Home network and SOHO

Programming

IPv6

Applications

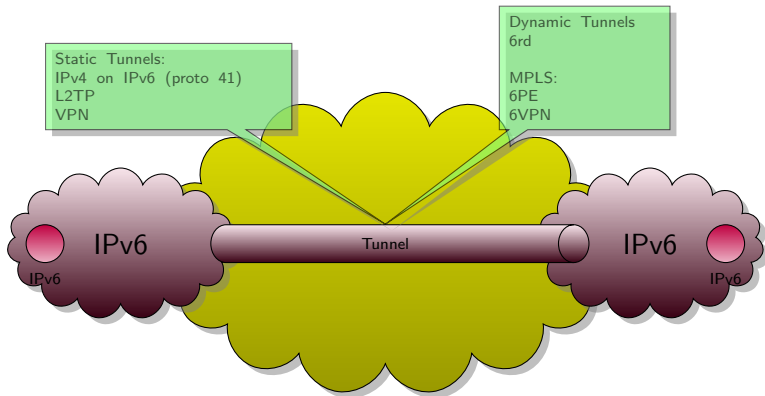

An IPv6 system connects to an IPv6 system through an IPv4 network

Integration

Why IPv6

Integration ?

6 generic scenarios

Tools overview

Scenarios

Backbone operator

Internet Access Provider

3G/LTE

Enterprise

Home network and SOHO

Programming

IPv6

Applications

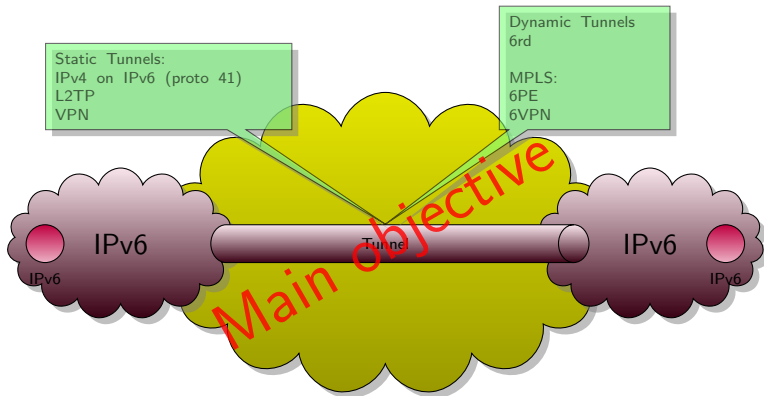

An IPv4 system connects to an IPv6 system

Integration

Why IPv6

Integration ?

6 generic scenarios

Tools overview

Scenarios

Backbone operator

Internet Access Provider

3G/LTE

Enterprise

Home network and SOHO

Programming

IPv6

Applications

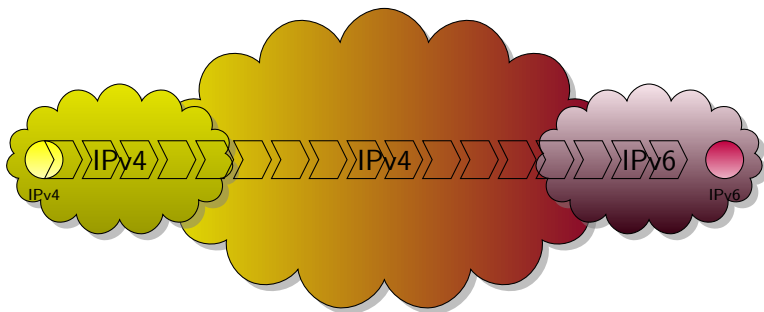

An IPv4 system connects to an IPv6 system

Integration

Why IPv6

Integration ?

6 generic scenarios

Tools overview

Scenarios

Backbone operator

Internet Access Provider

3G/LTE

Enterprise

Home network and SOHO

Programming

IPv6

Applications

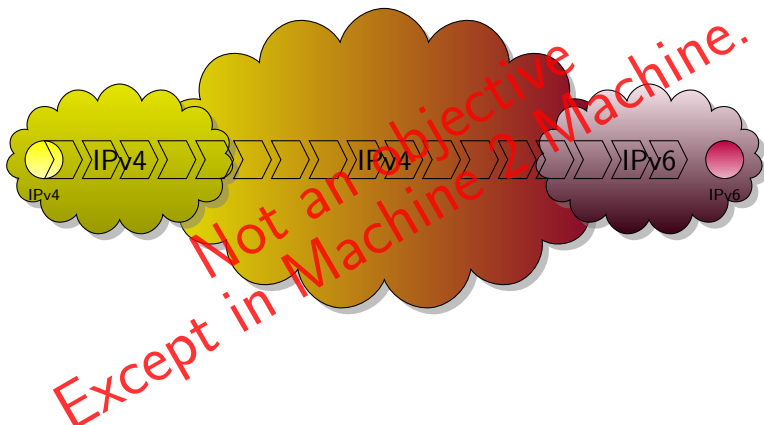

An IPv6 system connects to an IPv4 system

Integration

Why IPv6
Integration ?

6 generic scenarios

Tools overview

Scenarios

Backbone operator

Internet Access Provider

3G/LTE

Enterprise

Home network and SOHO

Programming

IPv6

Applications

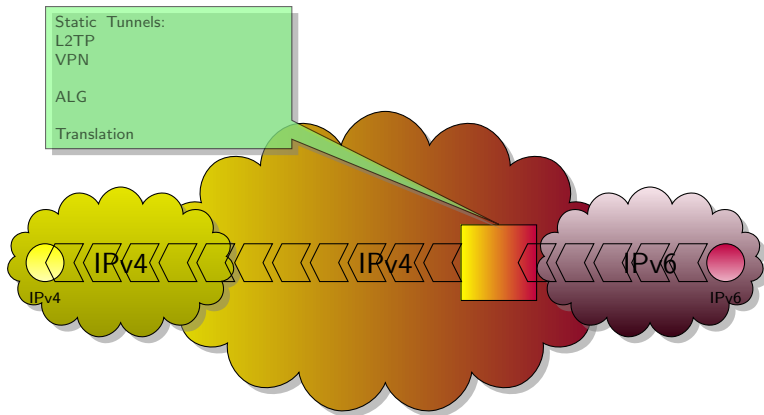

An IPv6 system connects to an IPv4 system

Integration

Why IPv6
Integration ?

6 generic scenarios

Tools overview

Scenarios

Backbone operator

Internet Access Provider

3G/LTE

Enterprise

Home network and SOHO

Programming

IPv6

Applications

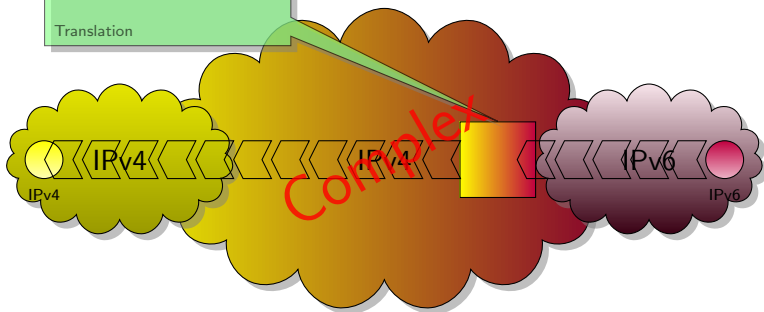
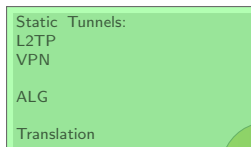

An IPv6 system connects to an IPv4 system

Integration

Why IPv6
Integration ?

6 generic scenarios

Tools overview

Scenarios

Backbone operator

Internet Access Provider

3G/LTE

Enterprise

Home network and SOHO

Programming

IPv6

Applications

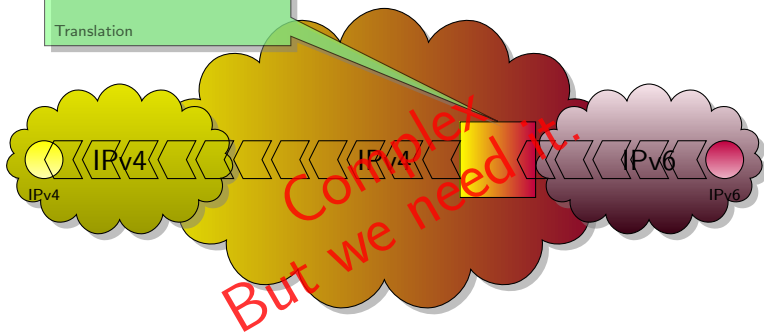
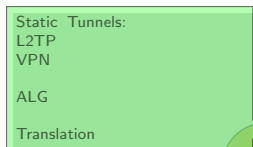

Integration

Tools overview

Rough Classification of Transition/Integration Mechanisms

Integration

Why IPv6

Integration ?

6 generic scenarios

Tools overview

Scenarios

Backbone operator

Internet Access Provider

3G/LTE

Enterprise

Home network and SOHO

Programming IPv6 Applications

Programming IPv6 Applications

Applications

Applications

- v6-v6 or v4-v4 Communication
 - Dual-Stack: v4 and v6 are fully available end-to-end
- Tunneling
 - v4 communication through a v6 network or vice versa
 - **automatic** vs **configured** (manual) tunnels
- v4-v6 co-existence/cross-communication
 - Translation
 - Header / protocol / port (v6→v4 and v4→v6)
 - Stateless vs Stateful
 - Relays / Application Level Gateways (ALG)

Integration

Why IPv6
Integration ?

6 generic
scenarios

Tools overview

Scenarios

Backbone
operator

Internet Access
Provider

3G/LTE

Enterprise

Home network
and SOHO

Programming

IPv6

Applications

- IPv4 and IPv6 running on the same box
- Especially useful for "Legacy" (existing) networks
 - *V6-fied* (legacy) IPv4 servers can provide the same service over IPv6 transport for new IPv6-only clients (web, mail, ftp, ssh...)
 - *V6-fied* (legacy) IPv4 clients can query new IPv6-only servers

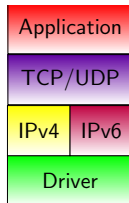
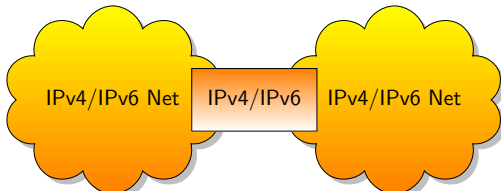

- But...
 - At least one IPv4 address is required for every node
 - ⇒ Alone, this approach does not fix the issue of IPv4 space exhaustion!
 - ⇒ Need to manage both protocols

Generic Approach for "Tunneling"

2 types of tunnels:

- Automatic Tunnels
 - Examples : 6to4, Teredo, ISATAP, 6PE/MPLS...
- Configured Tunnels
 - Manual, "Tunnel Broker"
- IP on IP cannot be NATed

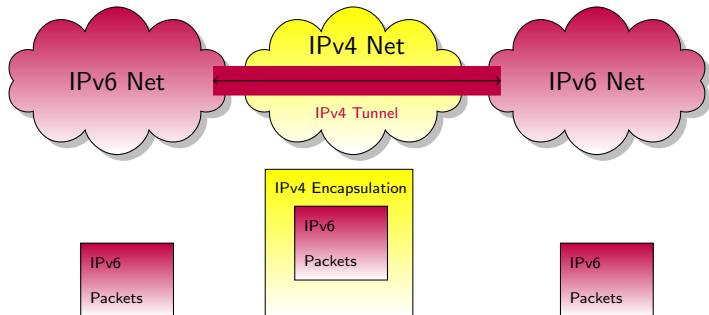

Integration

Why IPv6

Integration ?

6 generic scenarios

Tools overview

Scenarios

Backbone

operator

Internet Access

Provider

3G/LTE

Enterprise

Home network and SOHO

Programming

IPv6

Applications

Generic Approach for "Translation"

Integration

Why IPv6

Integration ?

6 generic scenarios

Tools overview

Scenarios

Backbone operator

Internet Access Provider

3G/LTE

Enterprise

Home network and SOHO

Programming

IPv6

Applications

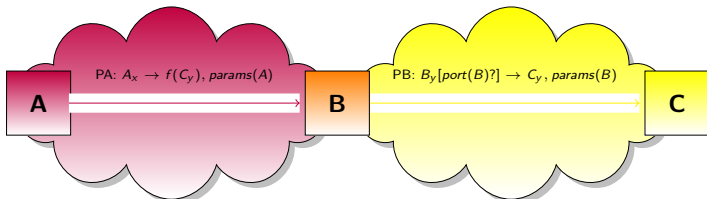

- $(x, y) \in \{(6, 4), (4, 6)\}$
- A is IP_{v_x} -only, C is IP_{v_y} -only
- A sends a packet PA to C
 - Source address: A_x
 - Destination address: $C_x = f(C_y)$ (an IP_{v_x} mapped to C_y)
- Packet PA is intercepted by B, the translation box supporting both IP_{v_x} and IP_{v_y}
- Packet PA is translated into packet PB, later sent to C
 - Source address: B_y from the "shared pool", potentially with a new port(B)
 - Destination address: C_y

Generic Approach for ALGs ("proxy")

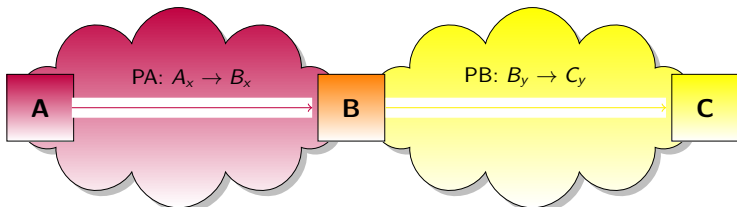

- $(x, y) \in \{(6, 4), (4, 6)\}$
- A is an IPv_x-only client; C is IPv_y-only server
- A sends to B a packet PA containing a request targeting C
 - Source address: A_x
 - Destination address: B_x
- B is a proxy supporting both IPv_x and IPv_y
- B sends to C a **new packet** PB, *proxying* A's request
 - Source address: B_y
 - Destination address: C_y
- Examples: proxy web/ftp/DNS/mail...

Integration Scenarios

Where to act, what to do exactly?

Integration

Why IPv6

Integration ?

6 generic scenarios

Tools overview

Scenarios

Backbone operator

Internet Access Provider

3G/LTE

Enterprise

Home network and SOHO

Programming

IPv6

Applications

- For ISPs/Operators
 - Backbone routers, Border routers (peering, transit)
 - Performances, Management
 - Access equipment (wired or wireless)
 - Prefix Allocation
- For users (individuals, enterprise, campus...):
 - LAN (routers if any)
 - Firewalls
 - Connectivity (CPE, PE)
 - Getting through their v4 ISP or bypassing it
- For everybody:
 - OS (local and distant)
 - Network applications or applications invoking the network even transiently

IPv6 is not mandatory everywhere to start Integration

Where to act, what to do exactly?

Integration

Why IPv6

Integration ?

6 generic scenarios

Tools overview

Scenarios

Backbone operator

Internet Access Provider

3G/LTE

Enterprise

Home network and SOHO

Programming

IPv6

Applications

- For ISPs/Operators
 - Backbone routers, Border routers (peering, transit)
 - Performances, Management
 - Access equipment (wired or wireless)
 - Prefix Allocation
- For users (individuals, enterprise, campus...):
 - LAN (routers if any)
 - Firewalls
 - Connectivity (CPE, PE)
 - Getting through their v4 ISP or bypassing it
- For everybody:
 - OS (local and distant)
 - Network applications or applications invoking the network even transiently

IPv6 is not mandatory everywhere to start Integration

Integration

Backbone operator

Integration

Why IPv6

Integration ?

6 generic scenarios

Tools overview

Scenarios

Backbone operator

Internet Access Provider

3G/LTE

Enterprise

Home network and SOHO

Programming

IPv6

Applications

- Forward IPv6 as fast as IPv4
- Some old routers forward IPv6 in the supervision card
 - bad performances
- Tunnel is not a good solution
 - bad performances due to encapsulation
- MPLS is your friend.
 - L2VPN
 - 6PE
 - 6VPN
- Few have the opposite problem:
 - How to carry IPv4 traffic on an IPv6 backbone
 - Softwires mesh

Integration

Internet Access Provider

Integration

Why IPv6

Integration ?

6 generic
scenarios

Tools overview

Scenarios

Backbone
operatorInternet Access
Provider

3G/LTE

Enterprise

Home network
and SOHO

Programming

IPv6

Applications

- Performances in forwarding (not so strict)
 - may use tunnels
- Allocate IPv6 prefixes
 - Lawfull IP address identification.
- May suffer from IPv4 shortage
- Different strategies exist

Define an addressing plan (Renater case study)

Integration

- Why IPv6
- Integration ?
- 6 generic scenarios

- Tools overview
- Scenarios
- Backbone operator

Internet Access Provider

- 3G/LTE
- Enterprise
- Home network and SOHO

Programming

- IPv6
- Applications

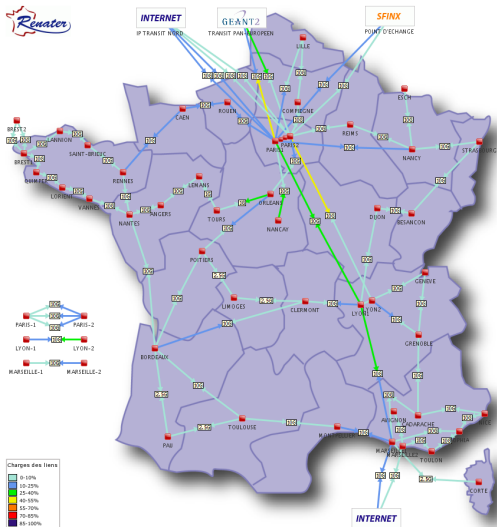

Define an addressing plan (Renater case study)

- Integration
- Why IPv6
- Integration ?
- 6 generic scenarios
- Tools overview
- Scenarios
- Backbone operator
- Internet Access Provider**
- 3G/LTE
- Enterprise
- Home network and SOHO
- Programming
- IPv6
- Applications

↓ RIPE-NCC
 2001:660::/32

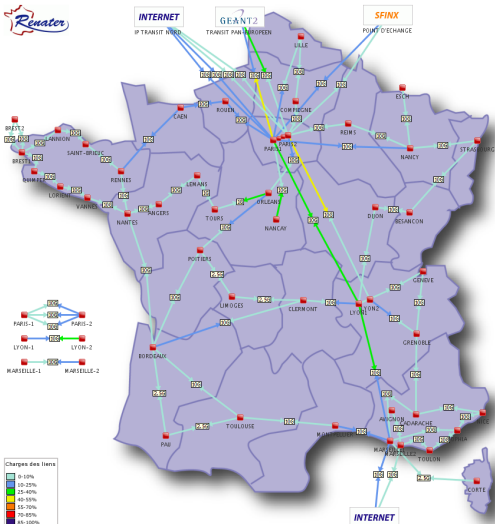

Define an addressing plan (Renater case study)

- Integration
- Why IPv6
- Integration ?
- 6 generic scenarios
- Tools overview
- Scenarios
- Backbone operator
- Internet Access Provider
- 3G/LTE
- Enterprise
- Home network and SOHO
- Programming
- IPv6
- Applications

↓ RIPE-NCC
 2001:660::/32
 ↓ POP
 2001:660:7300::/40

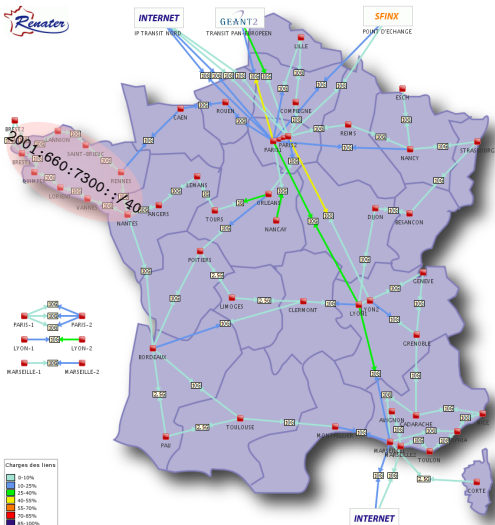

Define an addressing plan (Renater case study)

- Integration
- Why IPv6
- Integration ?
- 6 generic scenarios
- Tools overview
- Scenarios
- Backbone operator
- Internet Access Provider**
- 3G/LTE
- Enterprise
- Home network and SOHO
- Programming
- IPv6
- Applications

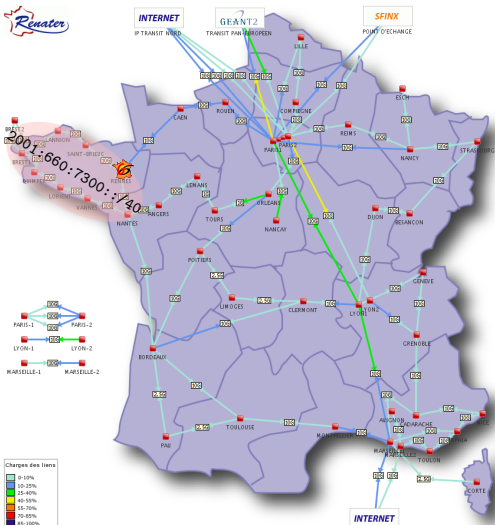
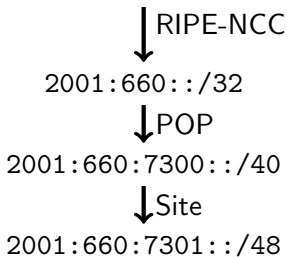

Integration

Why IPv6

Integration ?

6 generic scenarios

Tools overview

Scenarios

Backbone operator

Internet Access Provider

3G/LTE

Enterprise

Home network and SOHO

Programming

IPv6

Applications

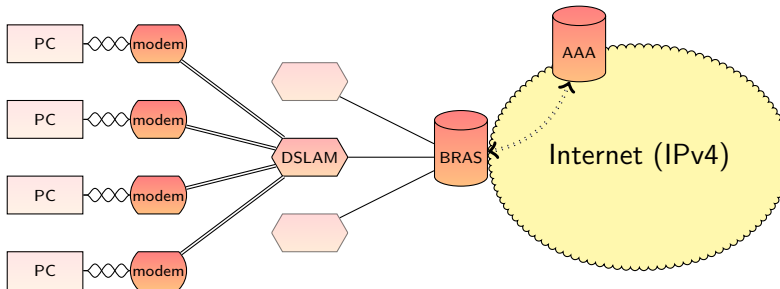

- Integration
- Why IPv6
- Integration ?
- 6 generic scenarios
- Tools overview
- Scenarios
- Backbone operator
- Internet Access Provider
- 3G/LTE
- Enterprise
- Home network and SOHO
- Programming IPv6
- Applications

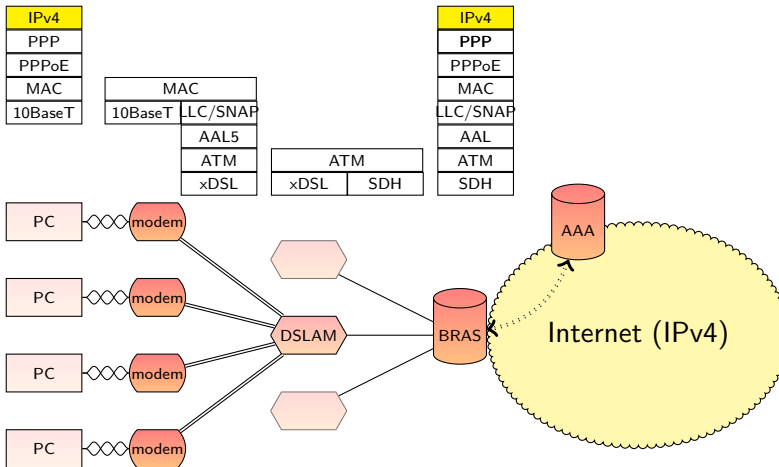

- Integration
- Why IPv6
- Integration ?
- 6 generic scenarios
- Tools overview
- Scenarios
- Backbone operator
- Internet Access Provider
- 3G/LTE
- Enterprise
- Home network and SOHO
- Programming IPv6
- Applications

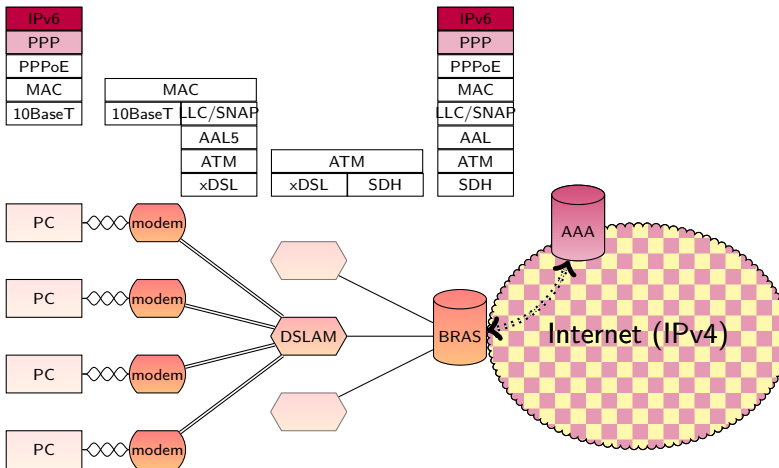

ADSL Architecture (Box or CPE)

- Integration
- Why IPv6
- Integration ?
- 6 generic scenarios
- Tools overview
- Scenarios
- Backbone operator
- Internet Access Provider**
- 3G/LTE
- Enterprise
- Home network and SOHO
- Programming IPv6
- Applications

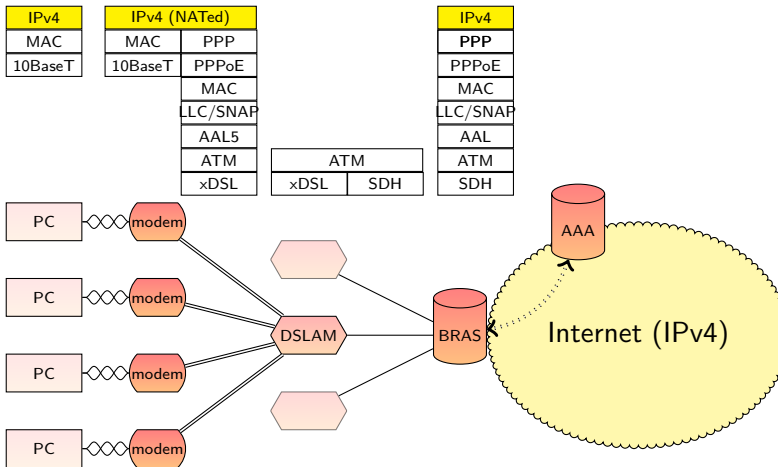

ADSL Architecture (Box or CPE)

- Integration
- Why IPv6
- Integration ?
- 6 generic scenarios
- Tools overview
- Scenarios
- Backbone operator
- Internet Access Provider**
- 3G/LTE
- Enterprise
- Home network and SOHO
- Programming IPv6
- Applications

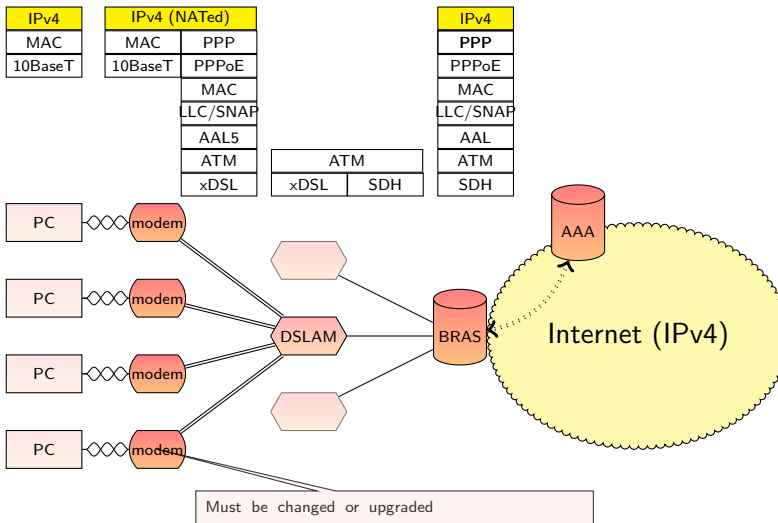

ADSL Architecture (3rd Generation DSLAM)

- Integration
- Why IPv6
- Integration ?
- 6 generic scenarios
- Tools overview
- Scenarios
- Backbone operator
- Internet Access Provider**
- 3G/LTE
- Enterprise
- Home network and SOHO
- Programming IPv6
- Applications

IPv4	IPv4 (NATed)		IPv4		IPv4
MAC	MAC	PPP	PPPE	PPP	PPP
10BaseT	10BaseT	PPPoE	PPPoE	SDH	SDH
		MAC	MAC		
		LLC/SNAP	LLC/SNAP		
		AAL5	AAL5		
		ATM	ATM		
		xDSL	xDSL		

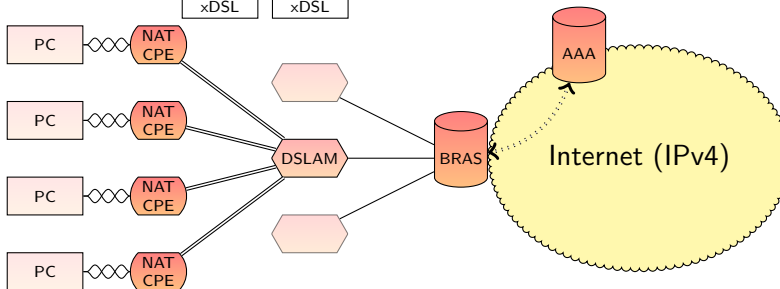

ADSL Architecture (3rd Generation DSLAM)

- Integration
- Why IPv6
- Integration ?
- 6 generic scenarios
- Tools overview
- Scenarios
- Backbone operator
- Internet Access Provider
- 3G/LTE
- Enterprise
- Home network and SOHO
- Programming IPv6
- Applications

IPv4	IPv4 (NATed)		IPv4		IPv4
MAC	MAC	PPP	PPPE	PPP	PPP
10BaseT	10BaseT	PPPoE	PPPoE	SDH	SDH
		MAC	MAC		
		LLC/SNAP	LLC/SNAP		
		AAL5	AAL5		
		ATM	ATM		
		xDSL	xDSL		

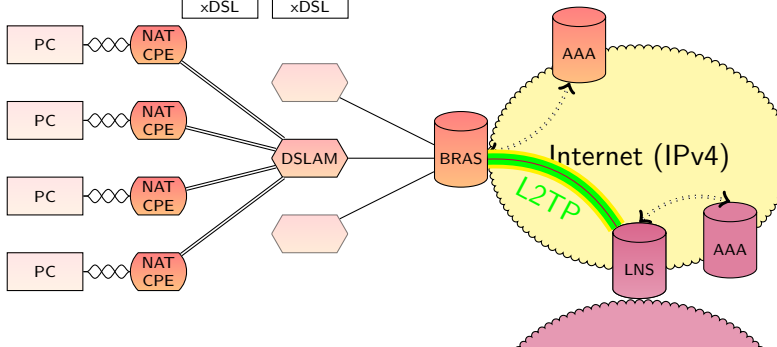

Integration

- Why IPv6
- Integration ?
- 6 generic scenarios
- Tools overview
- Scenarios
- Backbone operator
- Internet Access Provider**
- 3G/LTE
- Enterprise
- Home network and SOHO
- Programming IPv6
- Applications

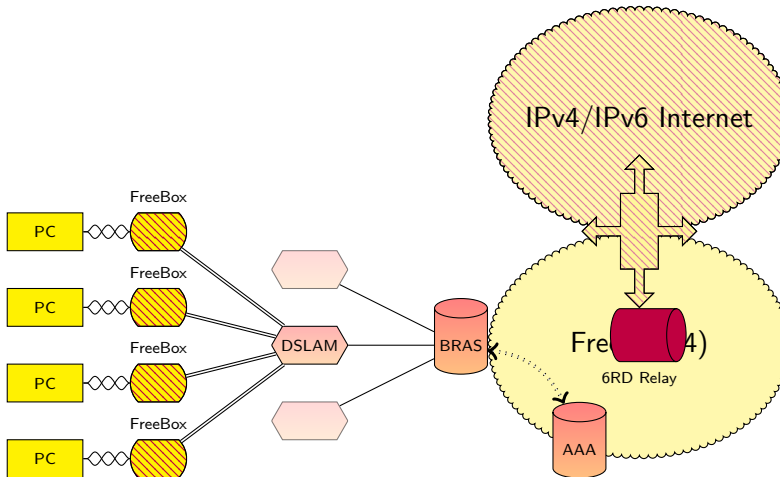

Integration

Why IPv6
Integration ?

6 generic
scenarios

Tools overview

Scenarios

Backbone
operator

**Internet Access
Provider**

3G/LTE

Enterprise

Home network
and SOHO

Programming

IPv6

Applications

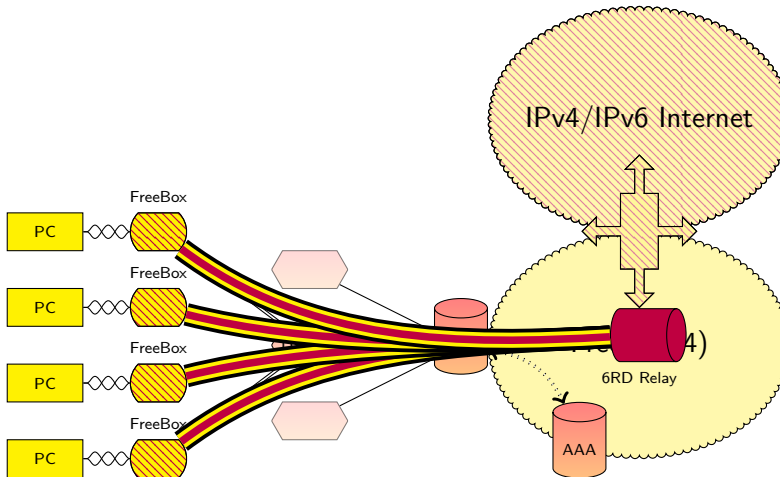

- Integration
- Why IPv6
- Integration ?
- 6 generic scenarios
- Tools overview
- Scenarios
- Backbone operator
- Internet Access Provider
- 3G/LTE
- Enterprise
- Home network and SOHO
- Programming IPv6
- Applications

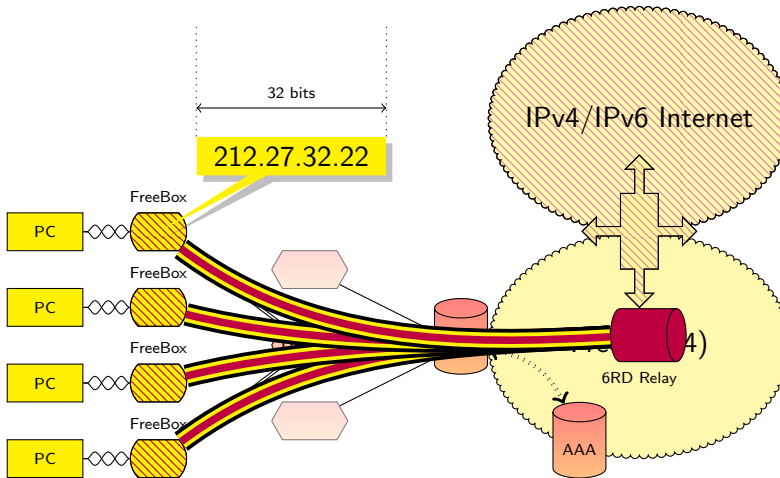

- Integration
- Why IPv6
- Integration ?
- 6 generic scenarios
- Tools overview
- Scenarios
- Backbone operator
- Internet Access Provider
- 3G/LTE
- Enterprise
- Home network and SOHO
- Programming IPv6
- Applications

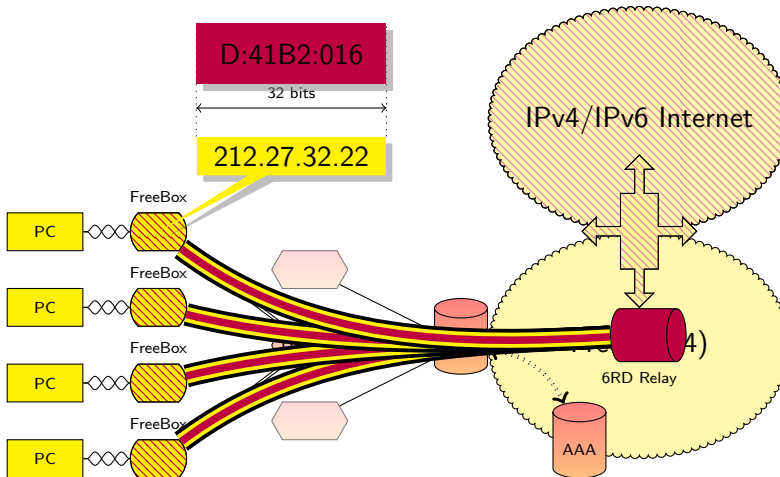

- Integration
- Why IPv6
- Integration ?
- 6 generic scenarios
- Tools overview
- Scenarios
- Backbone operator
- Internet Access Provider
- 3G/LTE
- Enterprise
- Home network and SOHO
- Programming IPv6
- Applications

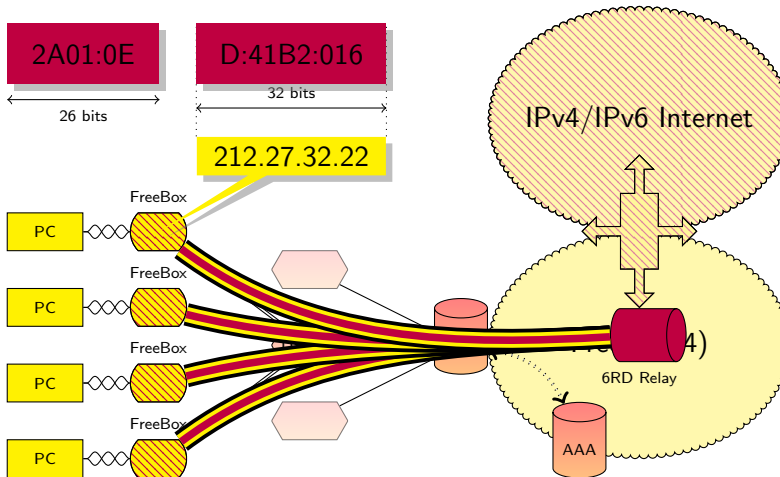

- Integration
- Why IPv6
- Integration ?
- 6 generic scenarios
- Tools overview
- Scenarios
- Backbone operator
- Internet Access Provider
- 3G/LTE
- Enterprise
- Home network and SOHO
- Programming IPv6
- Applications

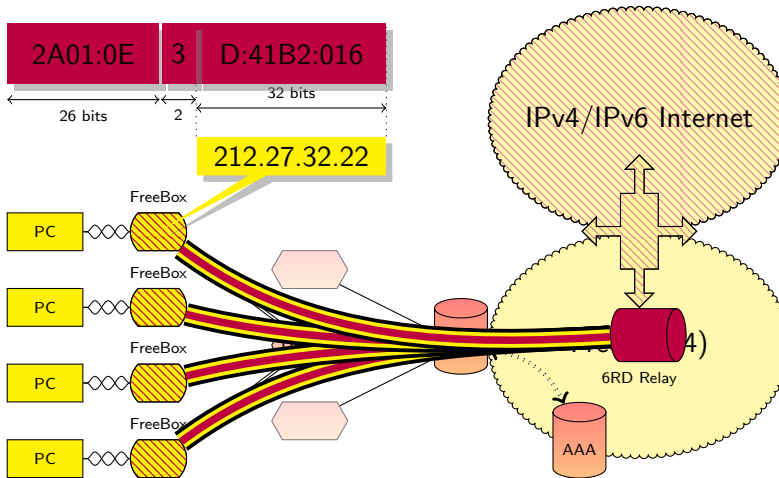

- Integration
- Why IPv6
- Integration ?
- 6 generic scenarios
- Tools overview
- Scenarios
- Backbone operator
- Internet Access Provider
- 3G/LTE
- Enterprise
- Home network and SOHO
- Programming IPv6
- Applications

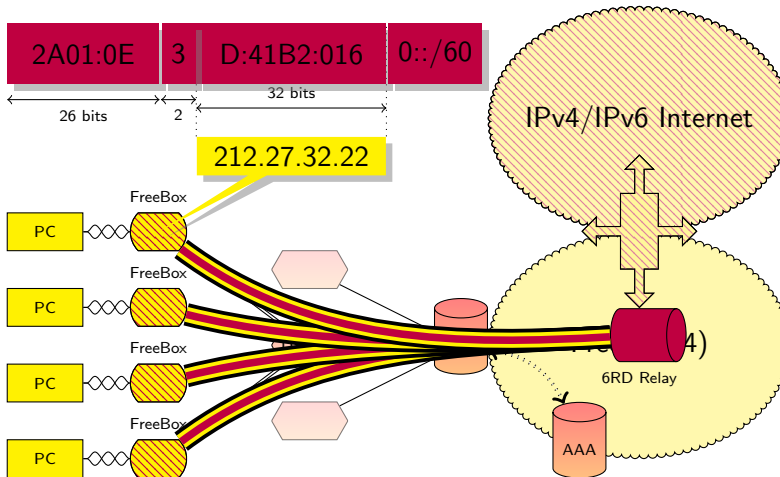

Integration

Why IPv6

Integration ?

6 generic scenarios

Tools overview

Scenarios

Backbone operator

Internet Access Provider

3G/LTE

Enterprise

Home network and SOHO

Programming

IPv6

Applications

- Core network or DSLAM are not changed:
 - only some 6RD relays and CPE modification.
- IPv6 prefixes are stable if IPv4 addresses are stable
- No need to manage/log IPv6 prefixes since IPv4 prefix is embedded
- 6RD relay is not used for internal traffic
- Deployed in Free Network in 2007 in 5 weeks.
- DHCPv4 option to setup 6RD relays (6RD Relays, and prefix lengths)
- Can work with IPv4 private addresses.

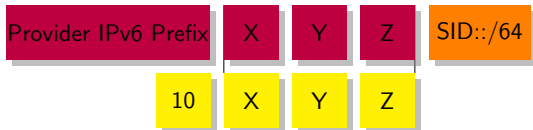

6rd: Mechanism

- Integration
- Why IPv6
- Integration ?
- 6 generic scenarios
- Tools overview
- Scenarios
- Backbone operator
- Internet Access Provider
- 3G/LTE
- Enterprise
- Home network and SOHO
- Programming IPv6 Applications

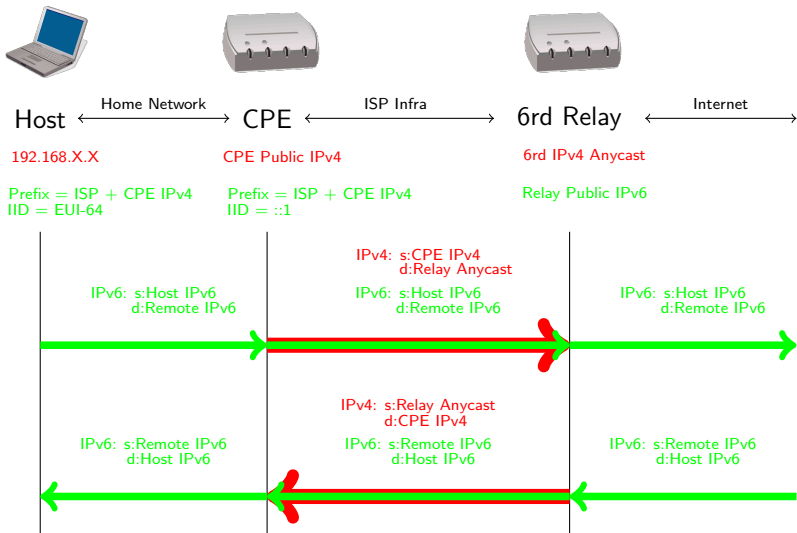

Integration

Why IPv6

Integration ?

6 generic scenarios

Tools overview

Scenarios

Backbone operator

Internet Access Provider

3G/LTE

Enterprise

Home network and SOHO

Programming

IPv6

Applications

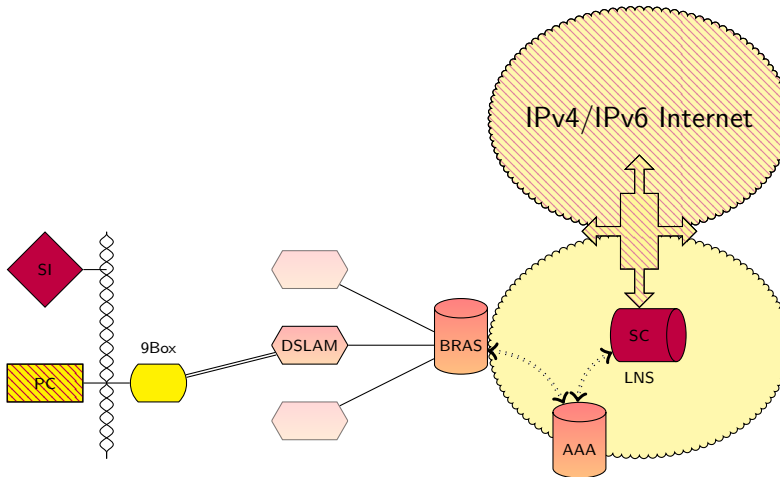

- Integration
- Why IPv6
- Integration ?
- 6 generic scenarios
- Tools overview
- Scenarios
- Backbone operator
- Internet Access Provider**
- 3G/LTE
- Enterprise
- Home network and SOHO
- Programming IPv6
- Applications

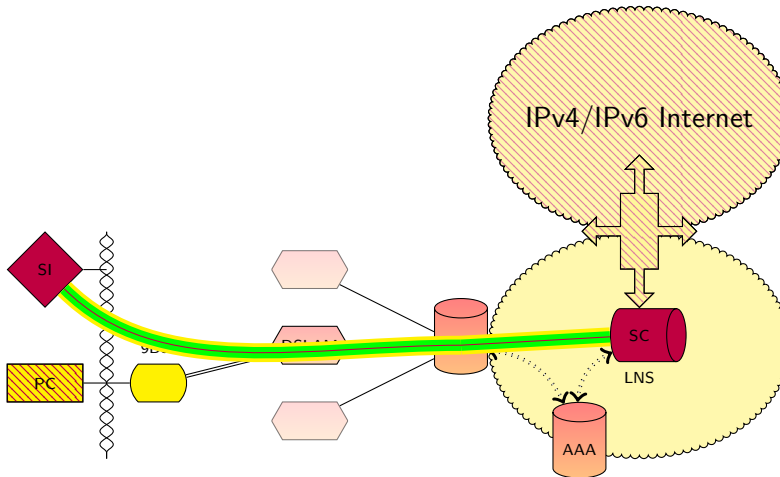

- Integration
- Why IPv6
- Integration ?
- 6 generic scenarios
- Tools overview
- Scenarios
- Backbone operator
- Internet Access Provider
- 3G/LTE
- Enterprise
- Home network and SOHO
- Programming IPv6
- Applications

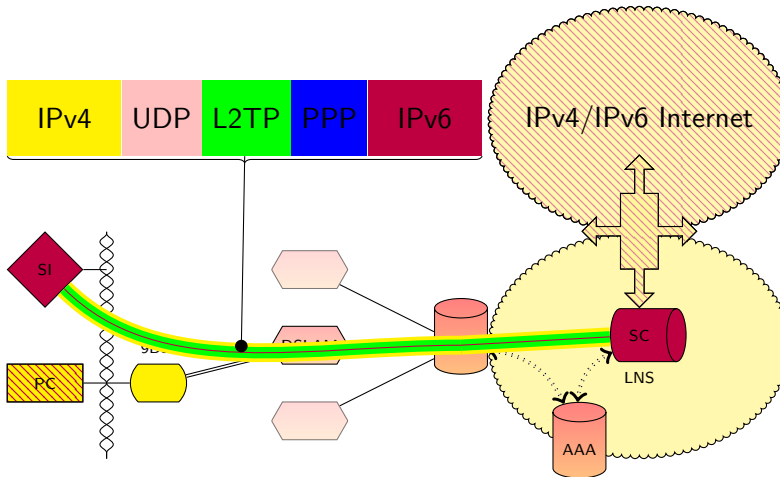

- Integration
- Why IPv6
- Integration ?
- 6 generic scenarios
- Tools overview
- Scenarios
- Backbone operator
- Internet Access Provider
- 3G/LTE
- Enterprise
- Home network and SOHO
- Programming IPv6 Applications

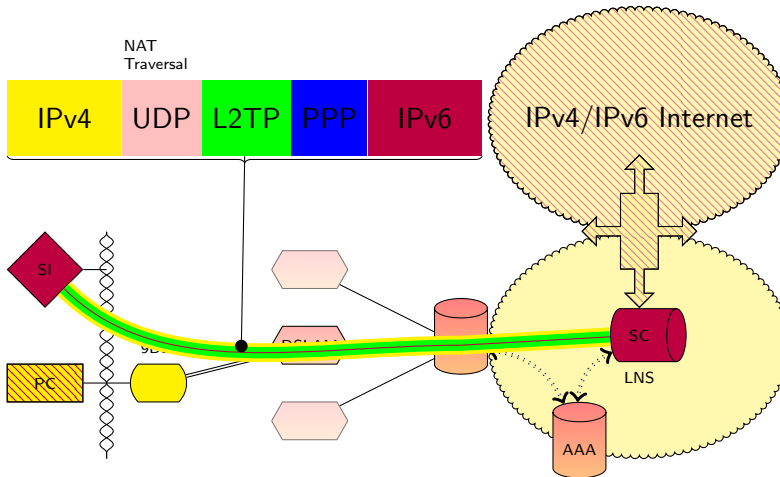

- Integration
- Why IPv6
- Integration ?
- 6 generic scenarios
- Tools overview
- Scenarios
- Backbone operator
- Internet Access Provider
- 3G/LTE
- Enterprise
- Home network and SOHO
- Programming IPv6
- Applications

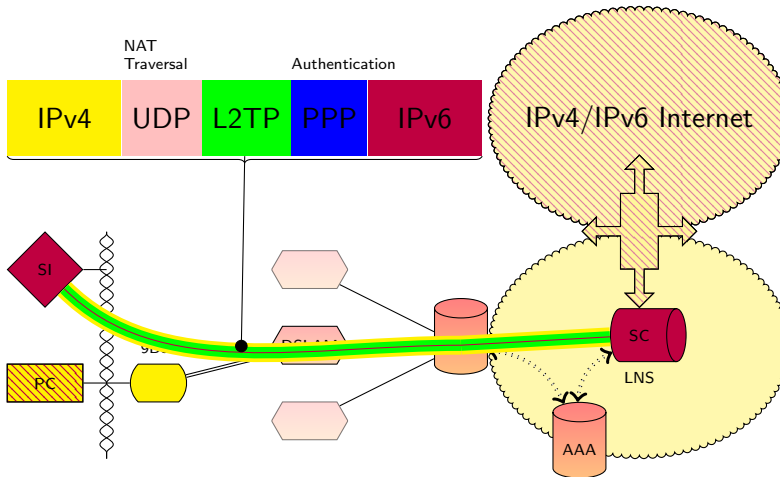

- Integration
- Why IPv6
- Integration ?
- 6 generic scenarios
- Tools overview
- Scenarios
- Backbone operator
- Internet Access Provider**
- 3G/LTE
- Enterprise
- Home network and SOHO
- Programming IPv6
- Applications

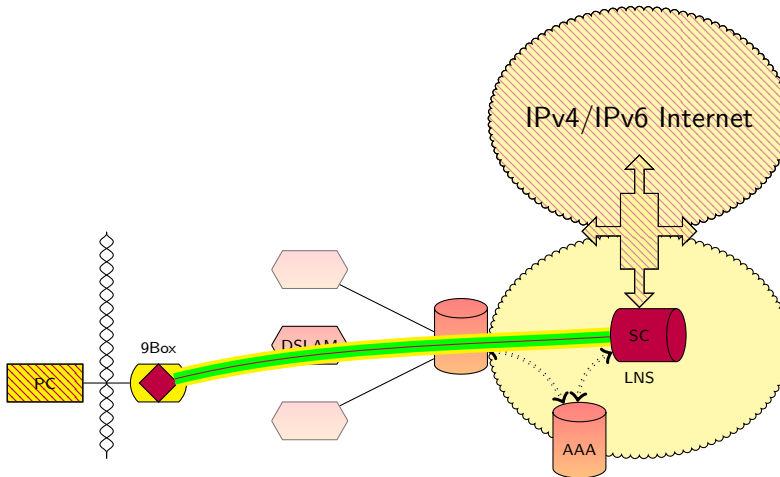

- Integration
- Why IPv6
- Integration ?
- 6 generic scenarios
- Tools overview
- Scenarios
- Backbone operator
- Internet Access Provider**
- 3G/LTE
- Enterprise
- Home network and SOHO
- Programming IPv6
- Applications

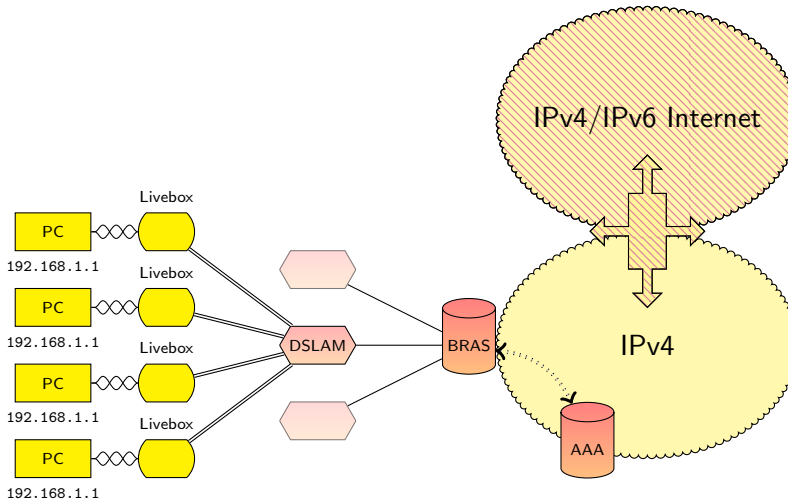

Integration

Why IPv6

Integration ?

6 generic scenarios

Tools overview

Scenarios

Backbone operator

Internet Access Provider

3G/LTE

Enterprise

Home network and SOHO

Programming

IPv6

Applications

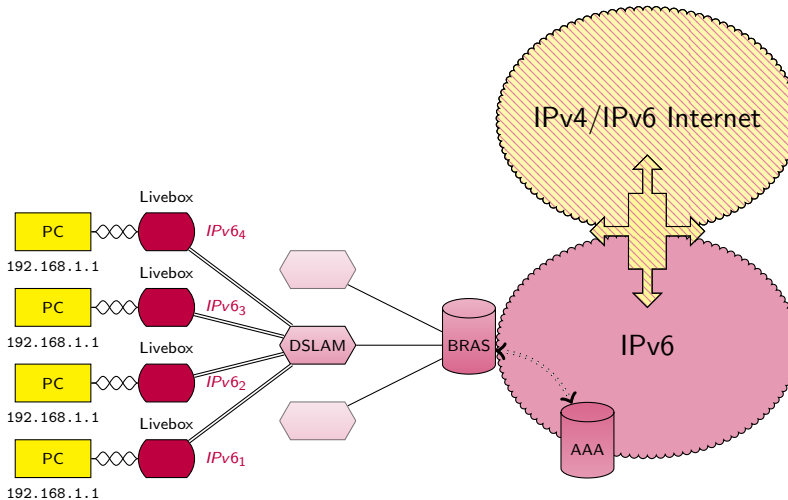

Integration

Why IPv6

Integration ?

6 generic scenarios

Tools overview

Scenarios

Backbone operator

Internet Access Provider

3G/LTE

Enterprise

Home network and SOHO

Programming

IPv6

Applications

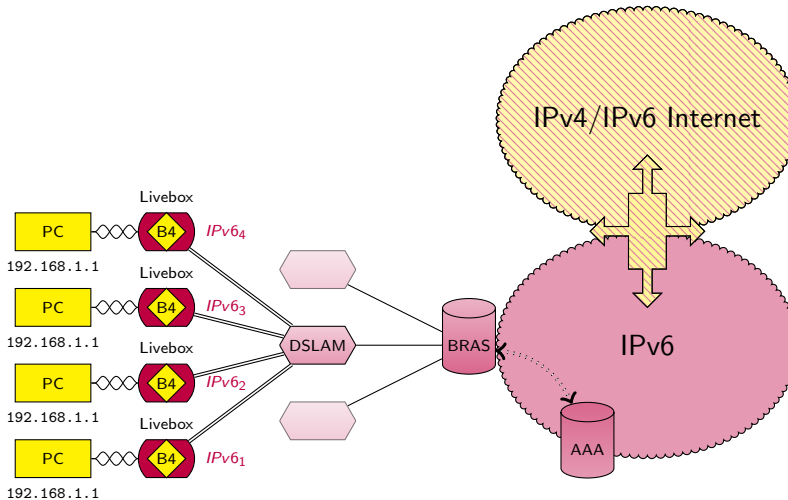

- Integration
- Why IPv6
- Integration ?
- 6 generic scenarios
- Tools overview
- Scenarios
- Backbone operator
- Internet Access Provider
- 3G/LTE
- Enterprise
- Home network and SOHO
- Programming IPv6
- Applications

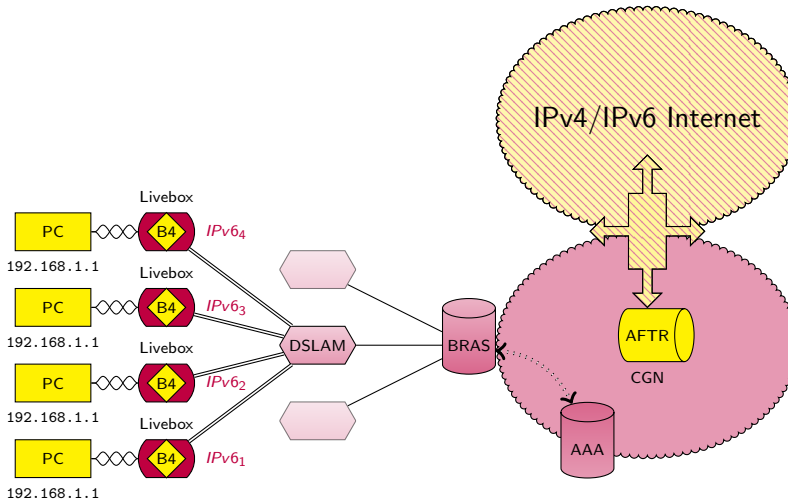

Integration

Why IPv6

Integration ?

6 generic scenarios

Tools overview

Scenarios

Backbone operator

Internet Access Provider

3G/LTE

Enterprise

Home network and SOHO

Programming

IPv6

Applications

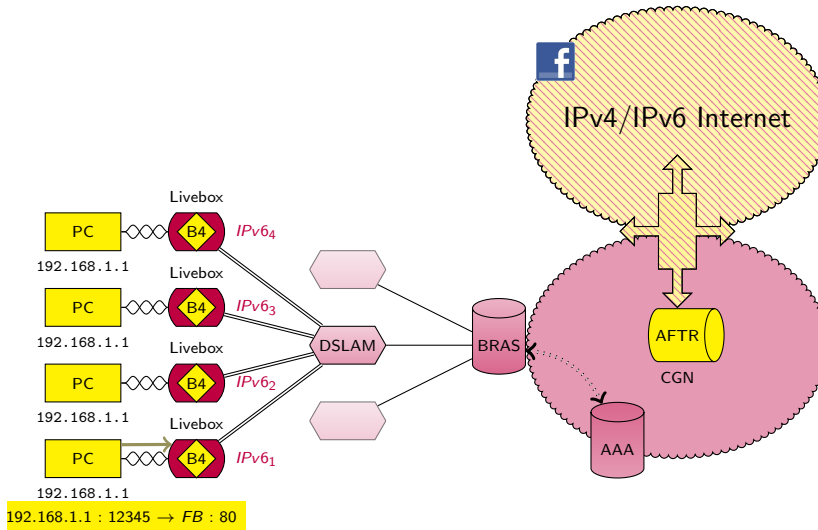

Integration

Why IPv6

Integration ?

6 generic scenarios

Tools overview

Scenarios

Backbone operator

Internet Access Provider

3G/LTE

Enterprise

Home network and SOHO

Programming

IPv6

Applications

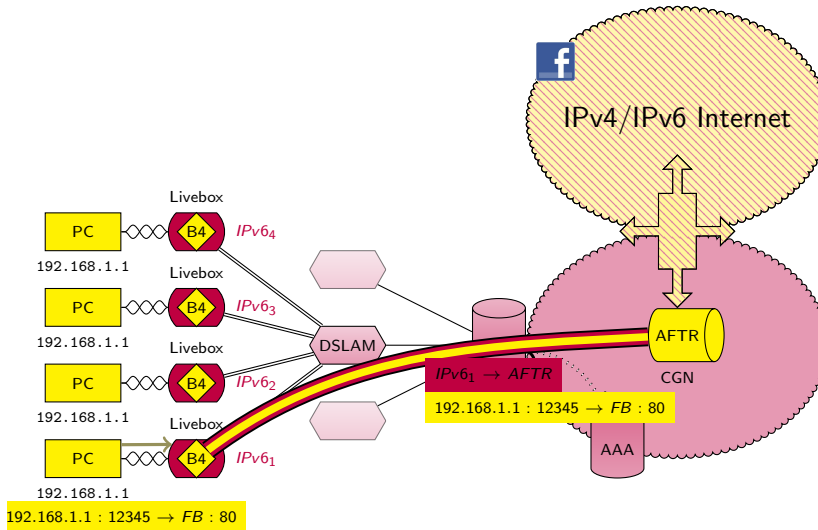

Integration

Why IPv6

Integration ?

6 generic scenarios

Tools overview

Scenarios

Backbone operator

Internet Access Provider

3G/LTE

Enterprise

Home network and SOHO

Programming

IPv6

Applications

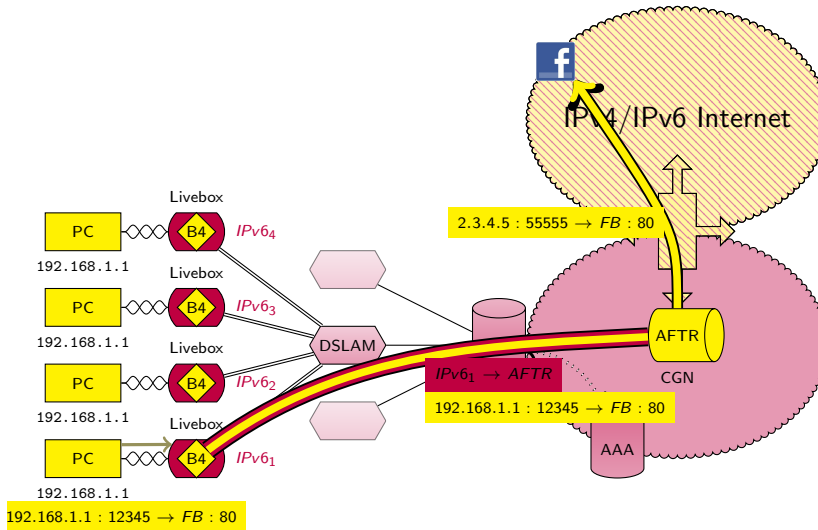

- Integration
- Why IPv6
- Integration ?
- 6 generic scenarios
- Tools overview
- Scenarios
- Backbone operator
- Internet Access Provider
- 3G/LTE
- Enterprise
- Home network and SOHO
- Programming IPv6 Applications

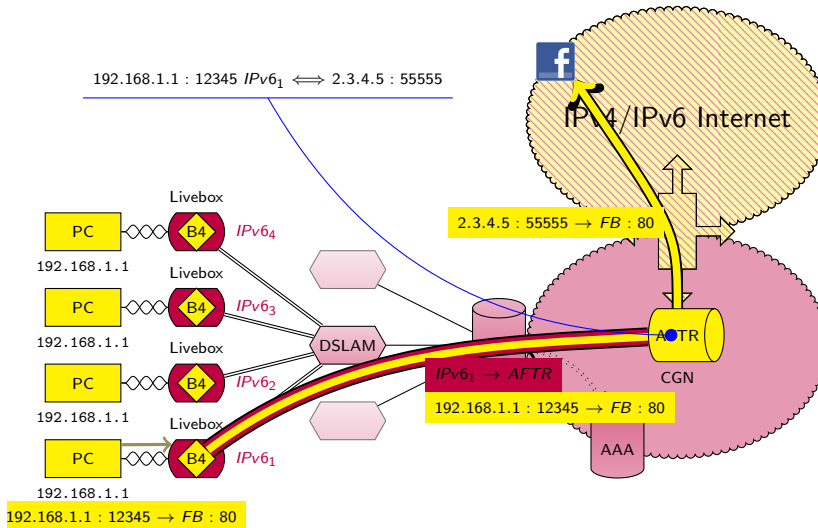

Integration

Why IPv6
Integration ?

6 generic scenarios

Tools overview

Scenarios

Backbone operator

Internet Access Provider

3G/LTE

Enterprise

Home network and SOHO

Programming

IPv6

Applications

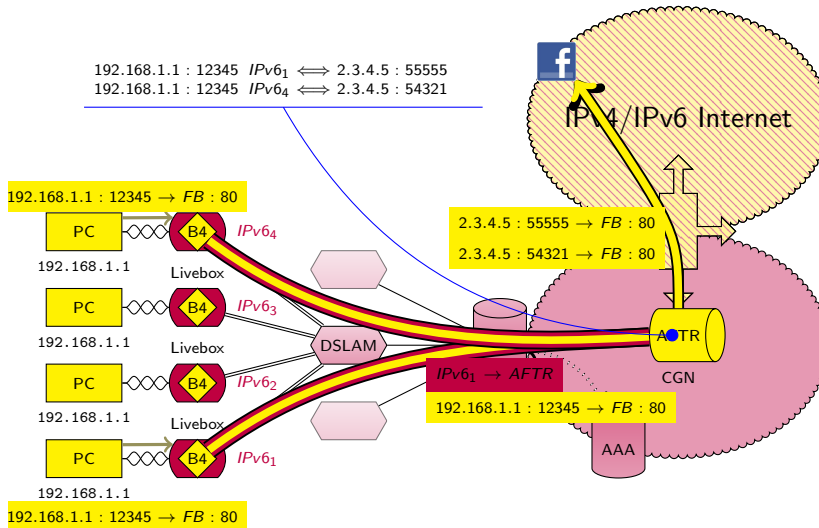

- Carrier Grade NAT deals with IPv4 address exhaustion:
 - No IPv4 address for the infrastructure
 - An IPv4 address is shared among several users
 - A user consumes about 300 port numbers
 - Less is needed (2 or 3 users per address)
- Less scalable than user NAT
 - More traffic from different users
 - for incoming traffic must map a port number to an IPv6 address
- Must take into account:
 - UPnP: Send UPnP traffic to CGN (see Port Control Protocol, [RFC 6887](#))
 - Static Mapping: Web page on AFTER
- Legal identification is complex:
 - Log per flow
 - Need IPv4 address, port number and time.

Integration

Why IPv6

Integration ?

6 generic scenarios

Tools overview

Scenarios

Backbone operator

Internet Access Provider

3G/LTE

Enterprise

Home network and SOHO

Programming IPv6

Applications

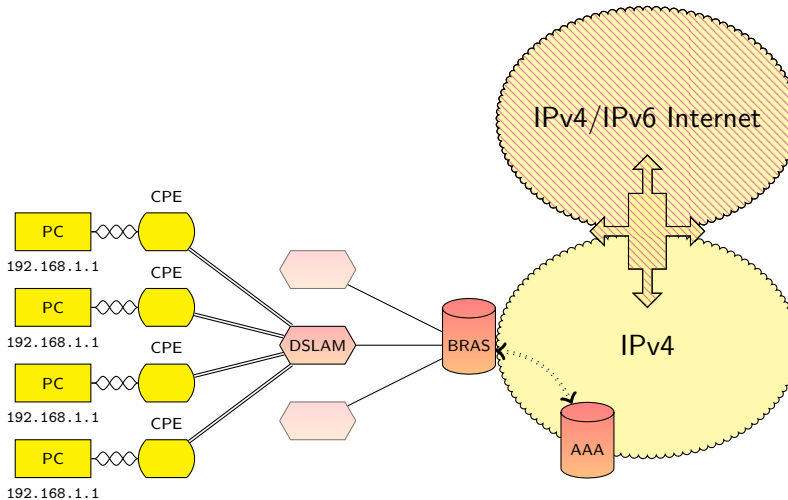

Integration

Why IPv6

Integration ?

6 generic scenarios

Tools overview

Scenarios

Backbone operator

Internet Access Provider

3G/LTE

Enterprise

Home network and SOHO

Programming

IPv6

Applications

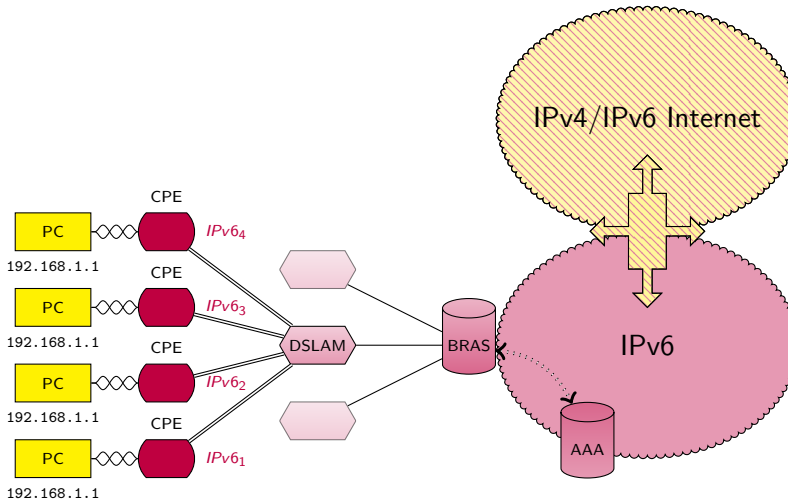

Integration

Why IPv6
Integration ?

6 generic scenarios

Tools overview

Scenarios

Backbone operator

Internet Access Provider

3G/LTE

Enterprise

Home network and SOHO

Programming IPv6

Applications

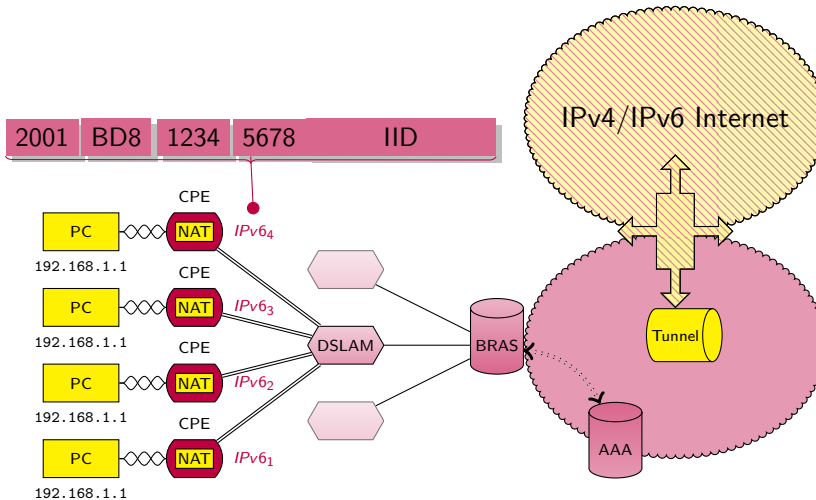

4rd (main idea)(RFC 7600)

Integration

Why IPv6

Integration ?

6 generic scenarios

Tools overview

Scenarios

Backbone operator

Internet Access Provider

3G/LTE

Enterprise

Home network and SOHO

Programming

IPv6

Applications

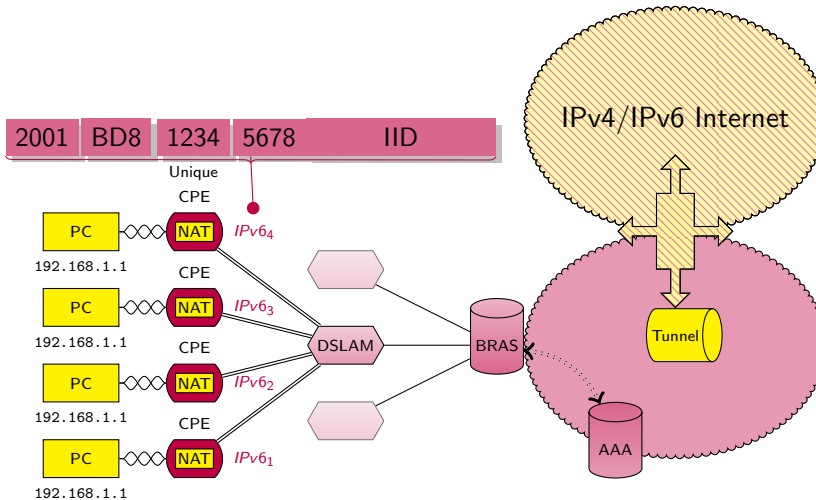

4rd (main idea)(RFC 7600)

- Integration
- Why IPv6
- Integration ?
- 6 generic scenarios
- Tools overview
- Scenarios
- Backbone operator
- Internet Access Provider
- 3G/LTE
- Enterprise
- Home network and SOHO
- Programming IPv6
- Applications

DHCPv6

2.3.4.

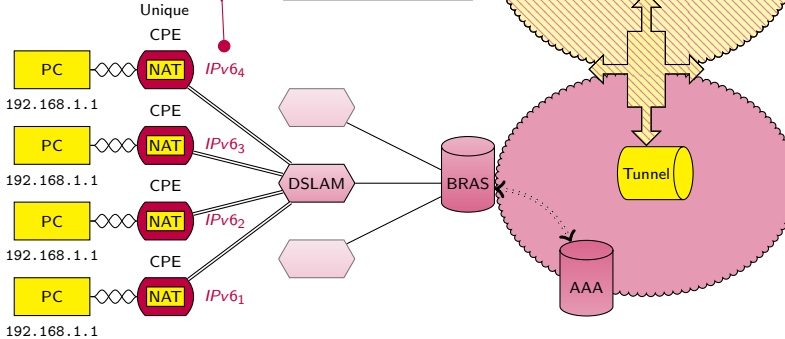

4rd (main idea)(RFC 7600)

- Integration
- Why IPv6
- Integration ?
- 6 generic scenarios
- Tools overview
- Scenarios
- Backbone operator
- Internet Access Provider
- 3G/LTE
- Enterprise
- Home network and SOHO
- Programming IPv6
- Applications

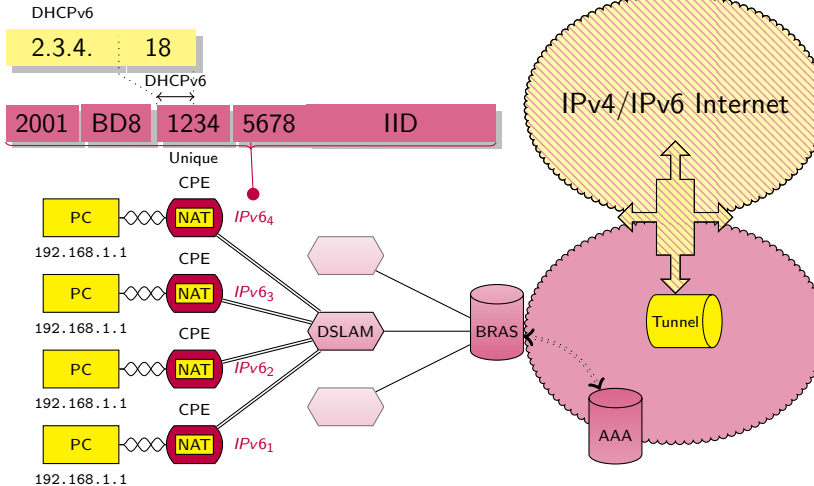

4rd (main idea)(RFC 7600)

- Integration
- Why IPv6
- Integration ?
- 6 generic scenarios
- Tools overview
- Scenarios
- Backbone operator
- Internet Access Provider
- 3G/LTE
- Enterprise
- Home network and SOHO
- Programming IPv6
- Applications

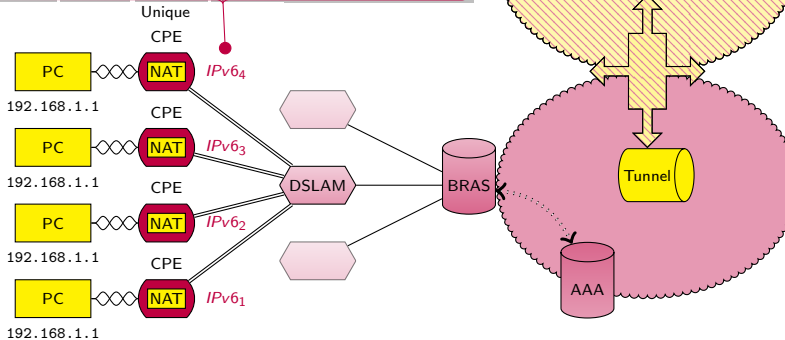
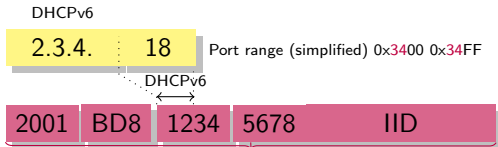

4rd (main idea)(RFC 7600)

- Integration
- Why IPv6
- Integration ?
- 6 generic scenarios
- Tools overview
- Scenarios
- Backbone operator
- Internet Access Provider
- 3G/LTE
- Enterprise
- Home network and SOHO
- Programming IPv6
- Applications

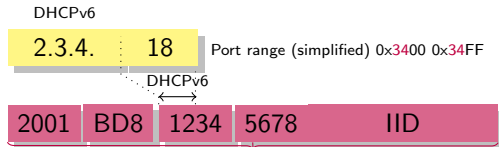

Unique
192.168.1.1 : 12345 → FB : 80

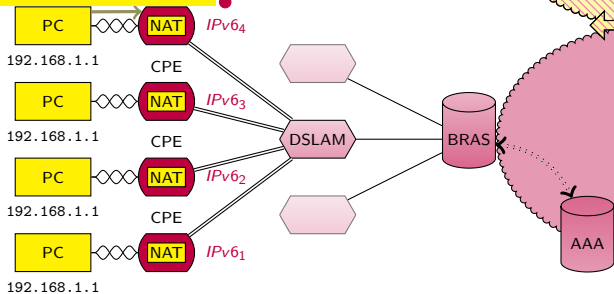

4rd (main idea)(RFC 7600)

- Integration
- Why IPv6
- Integration ?
- 6 generic scenarios
- Tools overview
- Scenarios
- Backbone operator
- Internet Access Provider
- 3G/LTE
- Enterprise
- Home network and SOHO
- Programming IPv6
- Applications

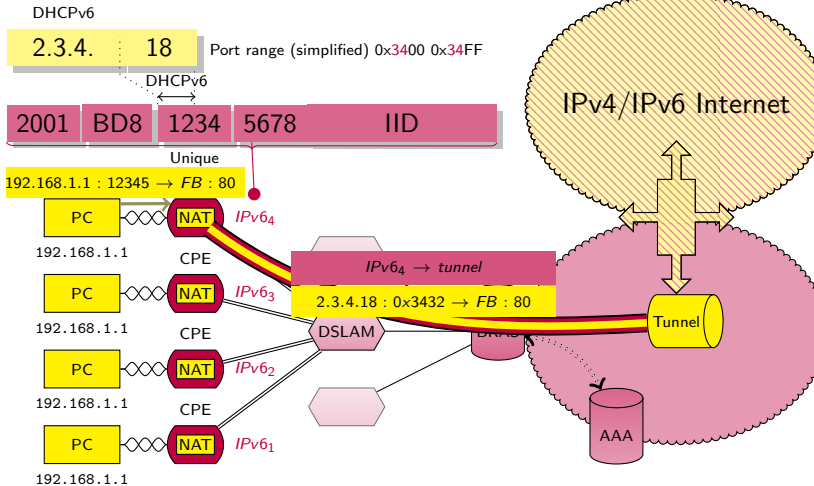

Integration

3G/LTE

Integration

Why IPv6

Integration ?

6 generic
scenarios

Tools overview

Scenarios

Backbone
operatorInternet Access
Provider**3G/LTE**

Enterprise

Home network
and SOHO

Programming

IPv6

Applications

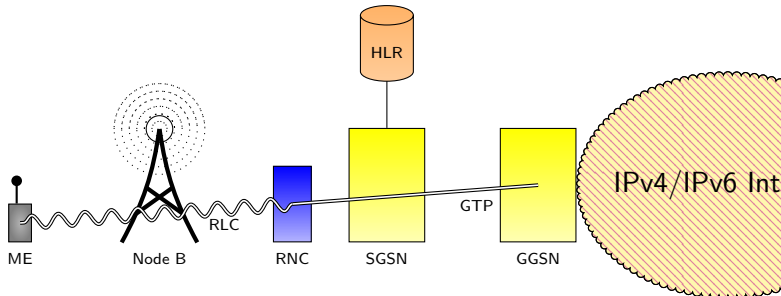

ME: Mobile Equipment, **RNC:** Radio Network Controller, **SGSN:** Serving GPRS Support Node, **GGSN:** Gateway GPRS Support Node, **HLR:** Home Location Register, **GTP:** GPRS Tunneling Protocol
RLC: Radio Link Control

Integration

Why IPv6

Integration ?

6 generic scenarios

Tools overview

Scenarios

Backbone operator

Internet Access Provider

3G/LTE

Enterprise

Home network and SOHO

Programming IPv6

Applications

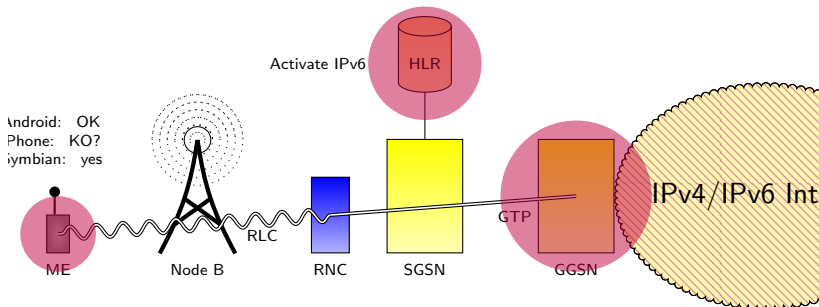

ME: Mobile Equipment, **RNC:** Radio Network Controller, **SGSN:** Serving GPRS Support Node, **GGSN:** Gateway GPRS Support Node, **HLR:** Home Location Register, **GTP:** GPRS Tunnelling Protocol
RLC: Radio Link Control

- Integration
- Why IPv6
- Integration ?
- 6 generic scenarios
- Tools overview
- Scenarios
- Backbone operator
- Internet Access Provider
- 3G/LTE
- Enterprise
- Home network and SOHO
- Programming IPv6
- Applications

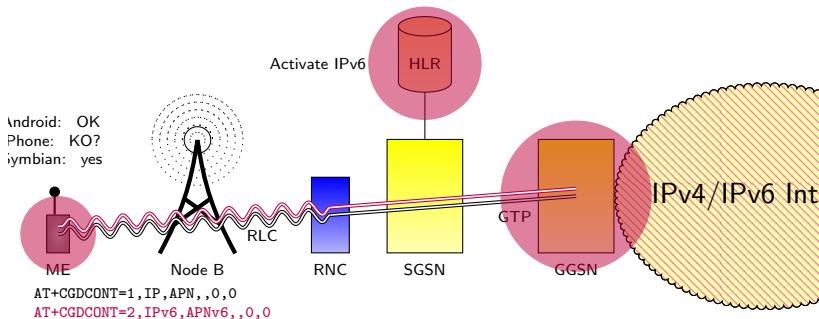

ME: Mobile Equipment, **RNC:** Radio Network Controller, **SGSN:** Serving GPRS Support Node, **GGSN:** Gateway GPRS Support Node, **HLR:** Home Location Register, **GTP:** GPRS Tunnelling Protocol
RLC: Radio Link Control

Integration

Why IPv6

Integration ?

6 generic scenarios

Tools overview

Scenarios

Backbone operator

Internet Access Provider

3G/LTE

Enterprise

Home network and SOHO

Programming IPv6

Applications

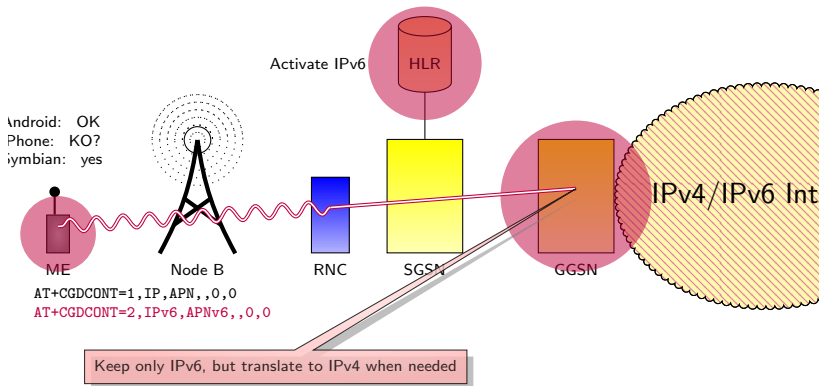

ME: Mobile Equipment, **RNC:** Radio Network Controller, **SGSN:** Serving GPRS Support Node, **GGSN:** Gateway GPRS Support Node, **HLR:** Home Location Register, **GTP:** GPRS Tunnelling Protocol
RLC: Radio Link Control

- Integration
- Why IPv6
- Integration ?
- 6 generic scenarios
- Tools overview
- Scenarios
- Backbone operator
- Internet Access Provider
- 3G/LTE**
- Enterprise
- Home network and SOHO
- Programming IPv6
- Applications

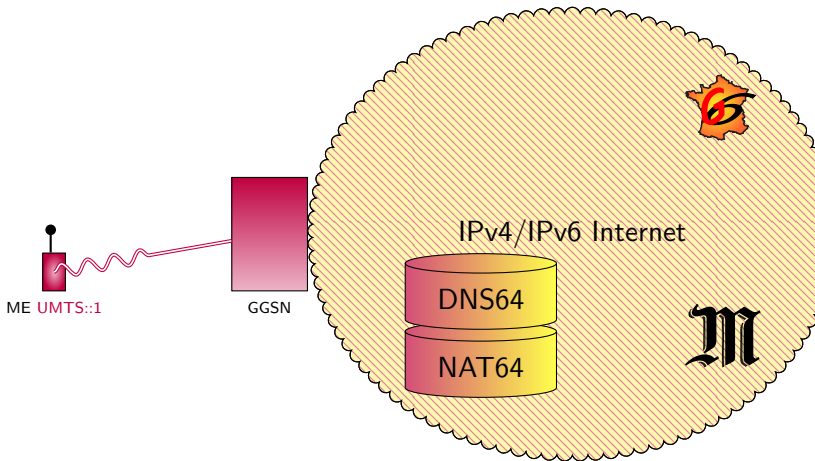

Integration

Why IPv6

Integration ?

6 generic scenarios

Tools overview

Scenarios

Backbone operator

Internet Access Provider

3G/LTE

Enterprise

Home network and SOHO

Programming IPv6

Applications

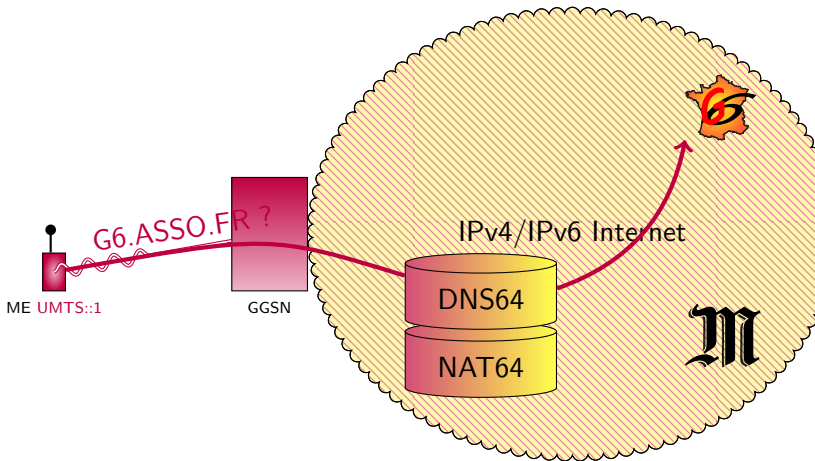

- Integration
- Why IPv6
- Integration ?
- 6 generic scenarios
- Tools overview
- Scenarios
- Backbone operator
- Internet Access Provider
- 3G/LTE**
- Enterprise
- Home network and SOHO
- Programming IPv6
- Applications

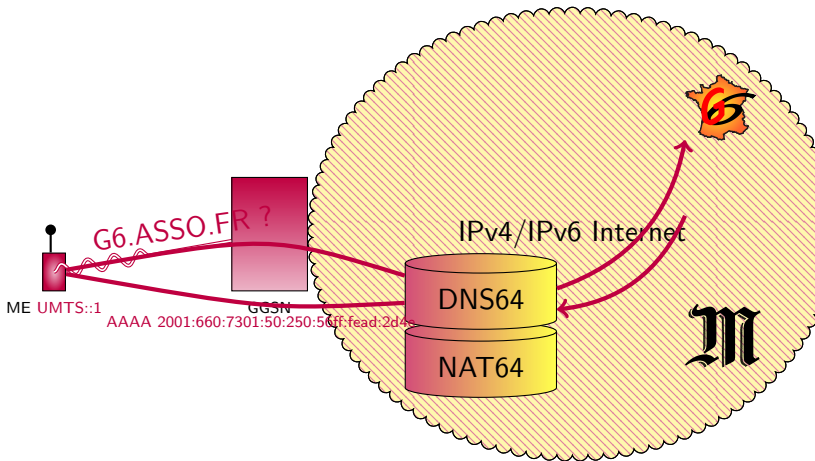

Integration

Why IPv6

Integration ?

6 generic scenarios

Tools overview

Scenarios

Backbone operator

Internet Access Provider

3G/LTE

Enterprise

Home network and SOHO

Programming

IPv6

Applications

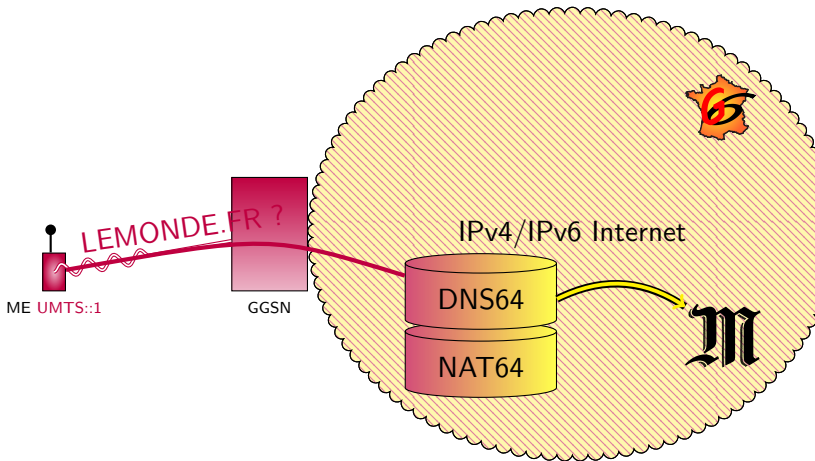

Integration

Why IPv6

Integration ?

6 generic scenarios

Tools overview

Scenarios

Backbone operator

Internet Access Provider

3G/LTE

Enterprise

Home network and SOHO

Programming

IPv6

Applications

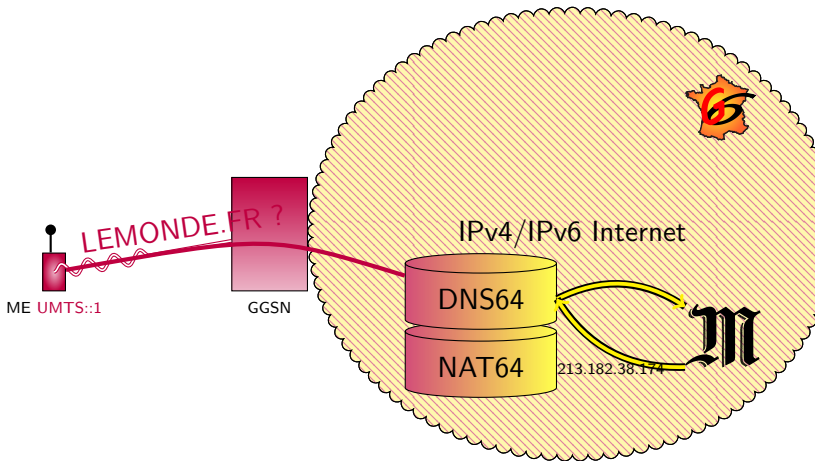

- Integration
- Why IPv6
- Integration ?
- 6 generic scenarios
- Tools overview
- Scenarios
- Backbone operator
- Internet Access Provider
- 3G/LTE**
- Enterprise
- Home network and SOHO
- Programming IPv6
- Applications

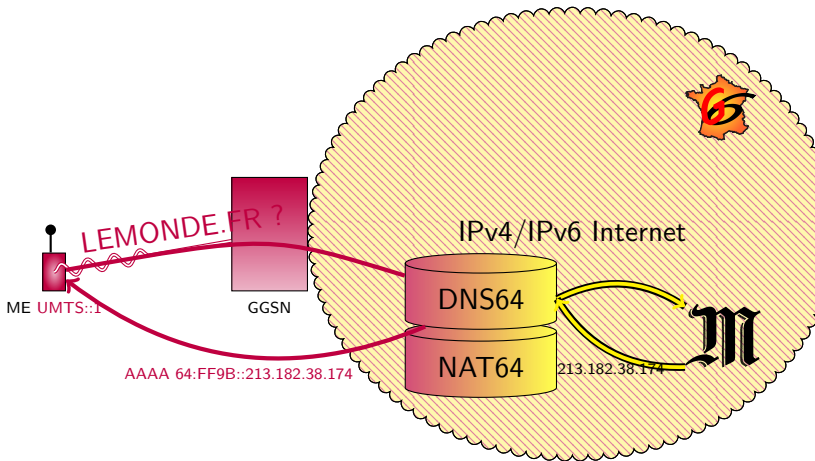

Integration

Why IPv6

Integration ?

6 generic scenarios

Tools overview

Scenarios

Backbone operator

Internet Access Provider

3G/LTE

Enterprise

Home network and SOHO

Programming

IPv6

Applications

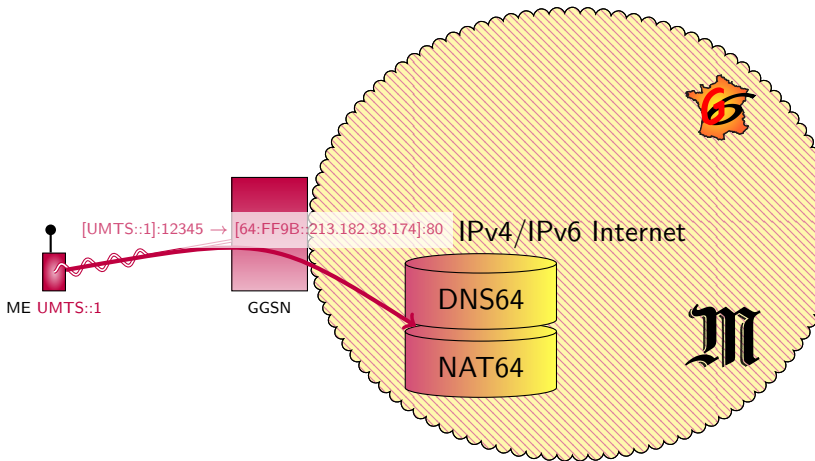

- Integration
- Why IPv6
- Integration ?
- 6 generic scenarios
- Tools overview
- Scenarios
- Backbone operator
- Internet Access Provider
- 3G/LTE**
- Enterprise
- Home network and SOHO
- Programming IPv6
- Applications

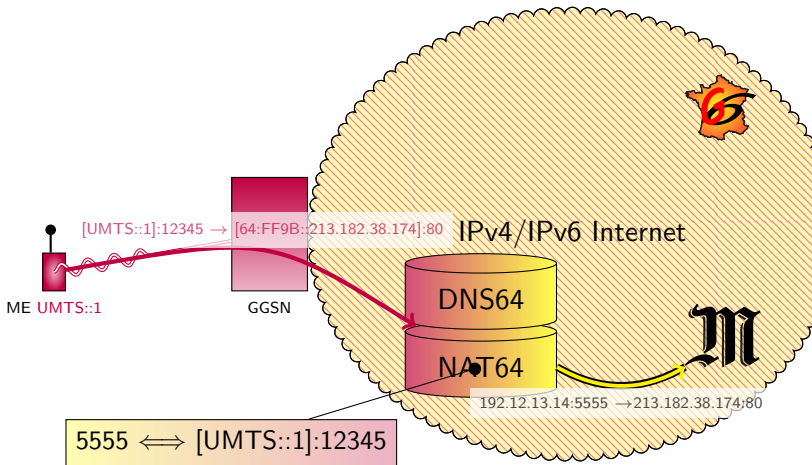

Integration

Enterprise

Integration

Why IPv6

Integration ?

6 generic scenarios

Tools overview

Scenarios

Backbone operator

Internet Access

Provider

3G/LTE

Enterprise

Home network and SOHO

Programming

IPv6

Applications

- Anticipate: include IPv6 in calls for tenders.
 - RIPE 501 is your friend ( <http://www.ripe.net/ripe/docs/ripe-501>)
- Define your goal:
 - Test: learn about IPv6 or develop products
 - Get temporary connectivity (Tunnel Brokers)
 - V6fy Extranet or/and Intranet
 - Get permanent connectivity and prefix
 - Define addressing plan
 - Define security rules

Integration

Why IPv6

Integration ?

6 generic scenarios

Tools overview

Scenarios

Backbone operator

Internet Access Provider

3G/LTE

Enterprise

Home network and SOHO

Programming

IPv6

Applications

- Hurricane Electric ([W tunnelbroker.com](http://www.tunnelbroker.com))
 - Standard and BGP tunnels
 - Point of Presence in Asia, North America and Europe
- sixxs ([W http://www.sixxs.net/main/](http://www.sixxs.net/main/))
 - Worldwide
- gogo6 ([W http://gogonet.gogo6.com/page/freenet6-tunnelbroker](http://gogonet.gogo6.com/page/freenet6-tunnelbroker))
 - Few Point of Presence
 - in Canada
 - NAT Traversal

Integration

Why IPv6

Integration ?

6 generic scenarios

Tools overview

Scenarios

Backbone operator

Internet Access Provider

3G/LTE

Enterprise

Home network and SOHO

Programming

IPv6

Applications

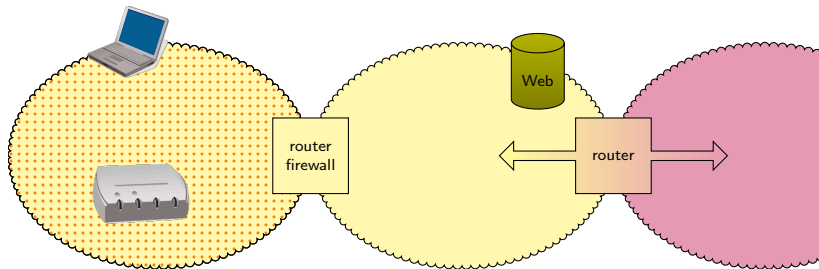

Integration

Why IPv6

Integration ?

6 generic scenarios

Tools overview

Scenarios

Backbone operator

Internet Access Provider

3G/LTE

Enterprise

Home network and SOHO

Programming

IPv6

Applications

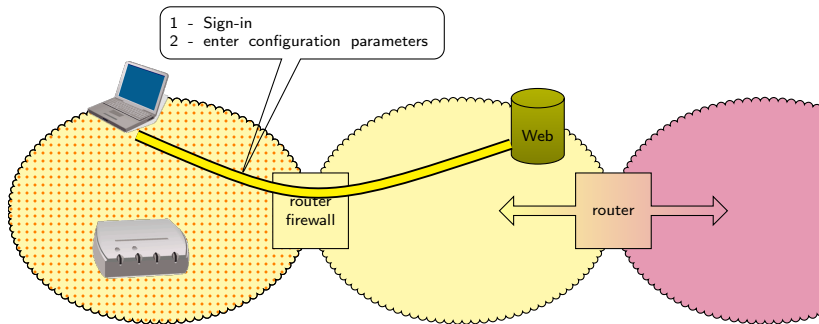

Integration

Why IPv6

Integration ?

6 generic scenarios

Tools overview

Scenarios

Backbone operator

Internet Access Provider

3G/LTE

Enterprise

Home network and SOHO

Programming

IPv6

Applications

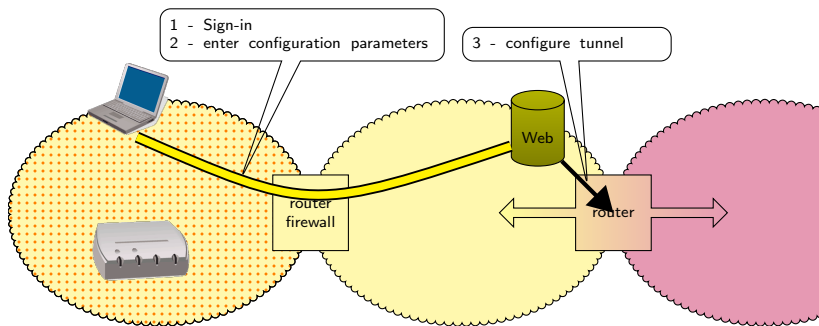

Integration

Why IPv6

Integration ?

6 generic scenarios

Tools overview

Scenarios

Backbone operator

Internet Access Provider

3G/LTE

Enterprise

Home network and SOHO

Programming

IPv6

Applications

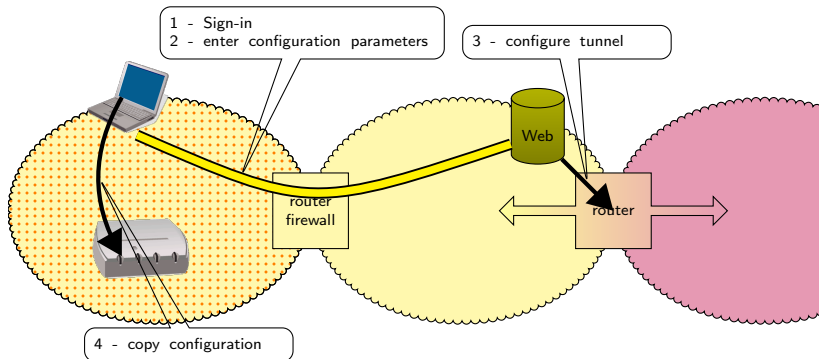

Integration

Why IPv6

Integration ?

6 generic scenarios

Tools overview

Scenarios

Backbone operator

Internet Access Provider

3G/LTE

Enterprise

Home network and SOHO

Programming

IPv6

Applications

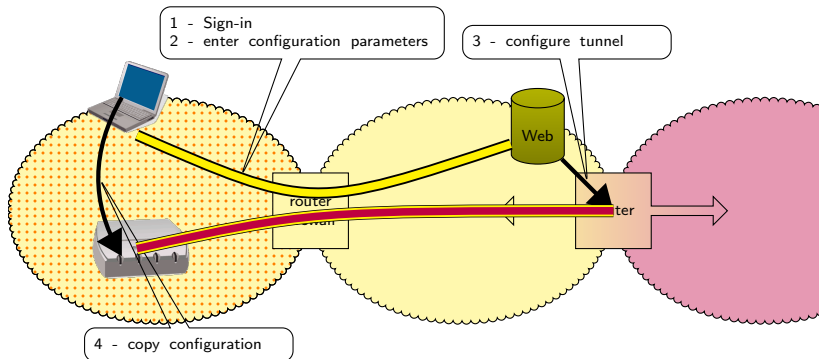

- Integration
- Why IPv6
- Integration ?
- 6 generic scenarios
- Tools overview
- Scenarios
- Backbone operator
- Internet Access Provider
- 3G/LTE
- Enterprise
- Home network and SOHO
- Programming IPv6
- Applications

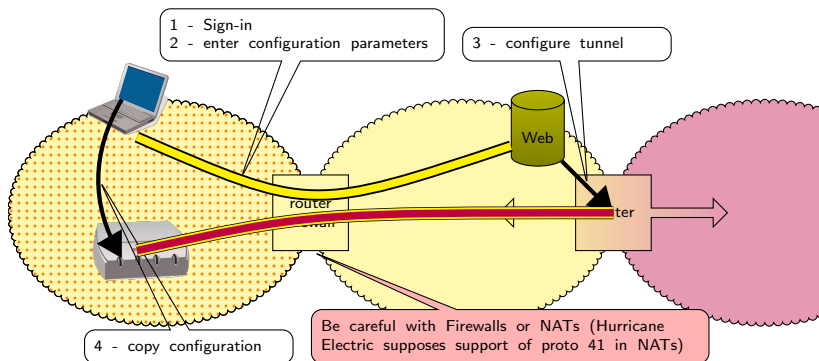

How to enable IPv6 access to a production Web site

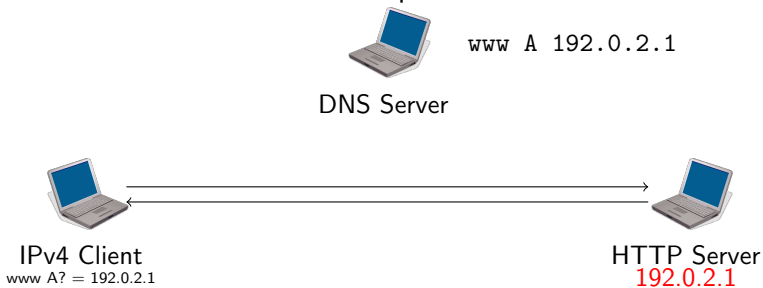

How to enable IPv6 access to a production Web site

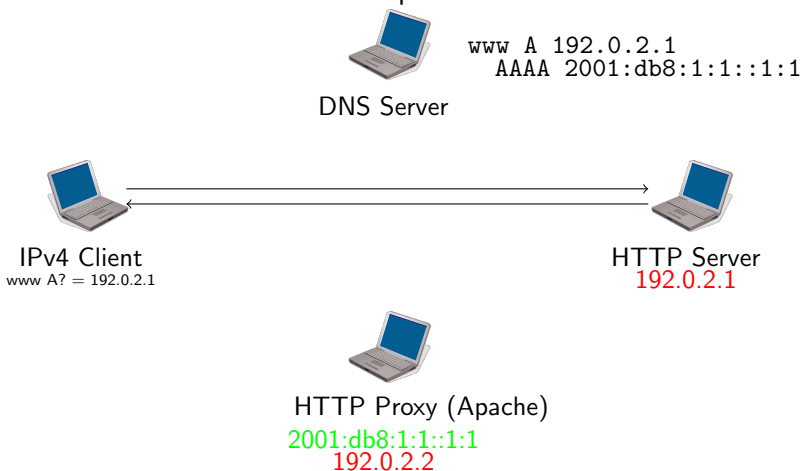

How to enable IPv6 access to a production Web site

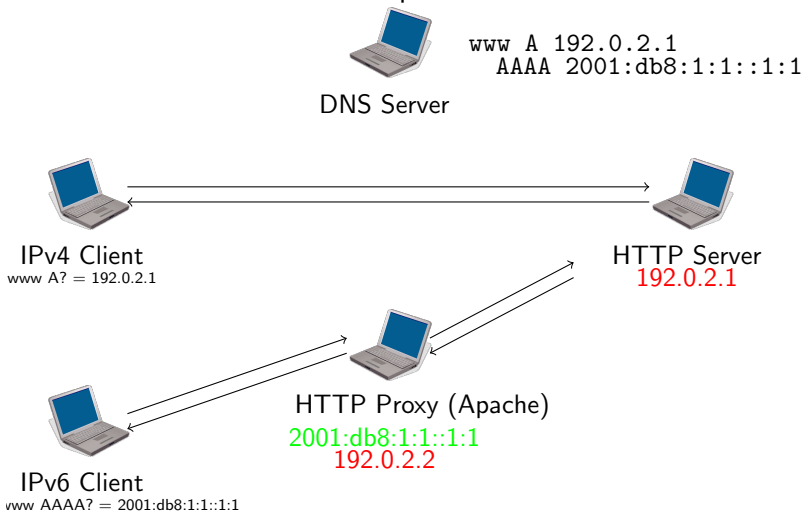

Integration

Why IPv6
Integration ?
6 generic
scenariosTools overview
Scenarios
Backbone
operator
Internet Access
Provider
3G/LTEEnterprise
Home network
and SOHOProgramming
IPv6
Applications

How to enable IPv6 access to a production Mail server

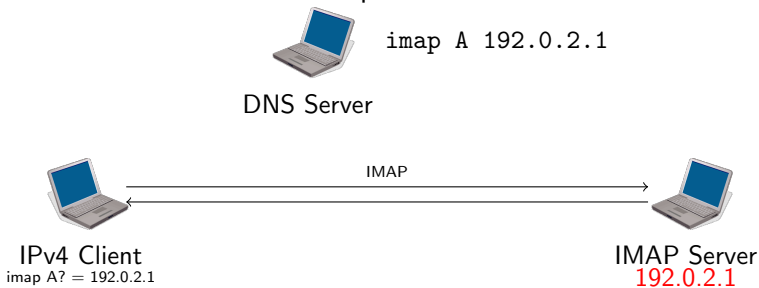

How to enable IPv6 access to a production Mail server

- Integration
- Why IPv6
- Integration ?
- 6 generic scenarios
- Tools overview
- Scenarios
- Backbone operator
- Internet Access Provider
- 3G/LTE
- Enterprise
- Home network and SOHO
- Programming
- IPv6
- Applications



 DNS Server

```
imap A 192.0.2.1
imap6 A 192.0.2.2
AAAA 2001:db8:1:1::1:1
```

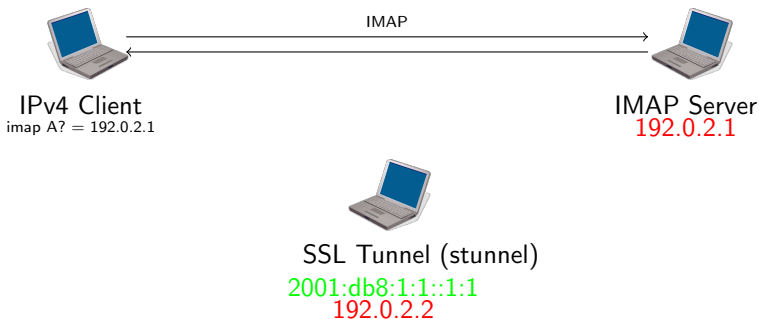

How to enable IPv6 access to a production Mail server

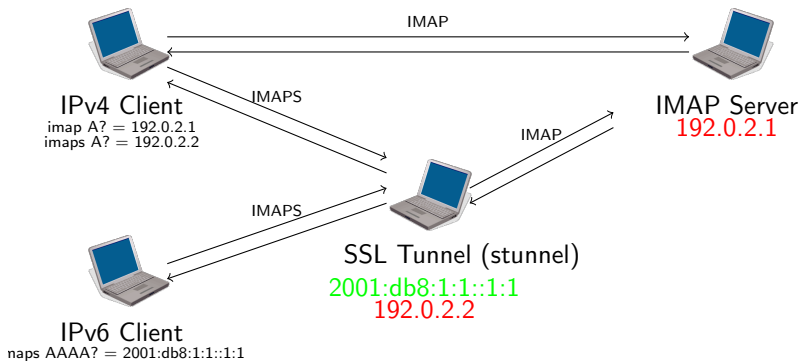
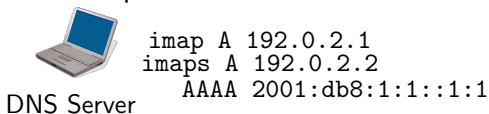

- Integration
- Why IPv6
- Integration ?
- 6 generic scenarios
- Tools overview
- Scenarios
- Backbone operator
- Internet Access Provider
- 3G/LTE
- Enterprise
- Home network and SOHO
- Programming
- IPv6
- Applications

Integration

Why IPv6

Integration ?

6 generic scenarios

Tools overview

Scenarios

Backbone operator

Internet Access Provider

3G/LTE

Enterprise

Home network and SOHO

Programming IPv6

Applications

Monitoring IPv6 is important for

- See impact of IPv6 deployment
- Ensure same Quality of Service in IPv4 and IPv6

Tools

- Traffic: MRTG/Cacti, Netflow v9...
- Services: Nagios, Zabbix...

Dual-Stack requires dual check !

Need to check service reachability BOTH in IPv4 AND in IPv6

Integration

Home network and SOHO

Integration

Why IPv6

Integration ?

6 generic scenarios

Tools overview

Scenarios

Backbone

operator

Internet Access

Provider

3G/LTE

Enterprise

Home network and SOHO

Programming

IPv6

Applications

- Must (should) be transparent for the end-users
- Last Mile is not currently v6fied
- Wait or used Tunnel Brokers
 - DO NOT USE TEREDO OR 6to4
- homenet IETF working group specifies home network behavior for IPv6
 - Today: star topology around single CPE
 - Tomorrow: Mesh network and multi-homing
 - Internet of things
 - smart grid
 - ...

Integration

Why IPv6

Integration ?

6 generic scenarios

Tools overview

Scenarios

Backbone operator

Internet Access Provider

3G/LTE

Enterprise

Home network and SOHO

Programming

IPv6

Applications

- based on the magic formula $16+32=48$
 - $2002::/16 + \text{IPv4 address}$

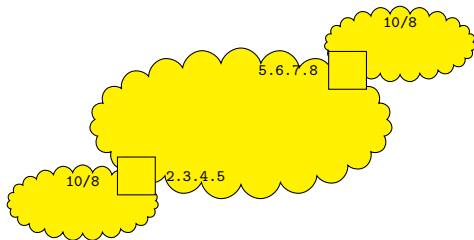

- Cannot cross NAT (need to know public address)
- Bad performances.

Integration

Why IPv6

Integration ?

6 generic
scenarios

Tools overview

Scenarios

Backbone
operatorInternet Access
Provider

3G/LTE

Enterprise

Home network
and SOHO

Programming

IPv6

Applications

- based on the magic formula $16+32=48$
 - $2002::/16 + \text{IPv4 address}$

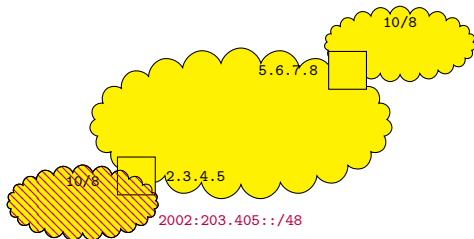

- Cannot cross NAT (need to know public address)
- Bad performances.

Integration

Why IPv6

Integration ?

6 generic scenarios

Tools overview

Scenarios

Backbone operator

Internet Access Provider

3G/LTE

Enterprise

Home network and SOHO

Programming

IPv6

Applications

- based on the magic formula $16+32=48$
 - $2002::/16 + \text{IPv4 address}$

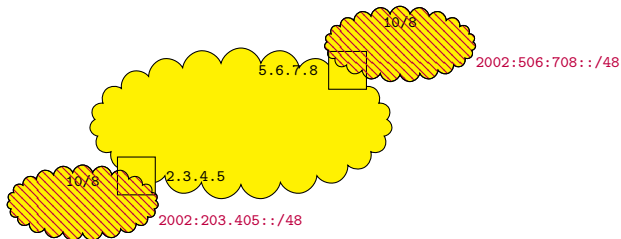

- Cannot cross NAT (need to know public address)
- Bad performances.

Integration

Why IPv6

Integration ?

6 generic scenarios

Tools overview

Scenarios

Backbone operator

Internet Access Provider

3G/LTE

Enterprise

Home network and SOHO

Programming IPv6

Applications

- based on the magic formula $16+32=48$
 - $2002::/16 + \text{IPv4 address}$

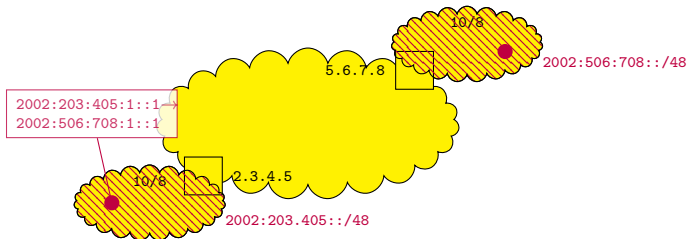

- Cannot cross NAT (need to know public address)
- Bad performances.

Integration

Why IPv6

Integration ?

6 generic scenarios

Tools overview

Scenarios

Backbone operator

Internet Access Provider

3G/LTE

Enterprise

Home network and SOHO

Programming

IPv6

Applications

- based on the magic formula $16+32=48$
 - $2002::/16 + \text{IPv4 address}$

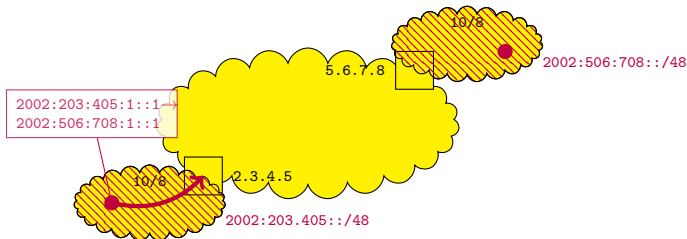

- Cannot cross NAT (need to know public address)
- Bad performances.

Integration

Why IPv6

Integration ?

6 generic scenarios

Tools overview

Scenarios

Backbone operator

Internet Access Provider

3G/LTE

Enterprise

Home network and SOHO

Programming IPv6

Applications

- based on the magic formula $16+32=48$
 - $2002::/16 + \text{IPv4 address}$

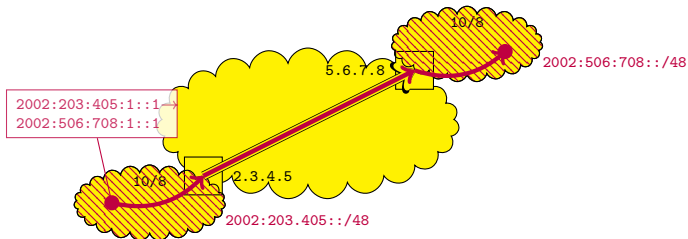

- Cannot cross NAT (need to know public address)
- Bad performances.

- based on the magic formula $16+32=48$
 - $2002::/16 + \text{IPv4 address}$

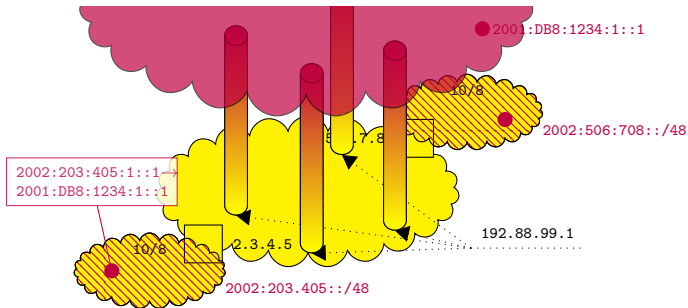

- Cannot cross NAT (need to know public address)
- Bad performances.

- based on the magic formula $16+32=48$
 - $2002::/16 + \text{IPv4 address}$

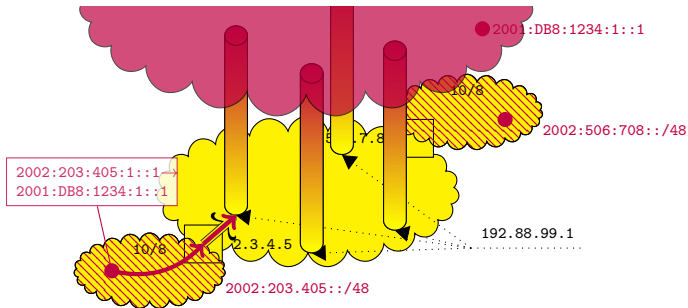

- Cannot cross NAT (need to know public address)
- Bad performances.

- based on the magic formula $16+32=48$
 - $2002::/16 + \text{IPv4 address}$

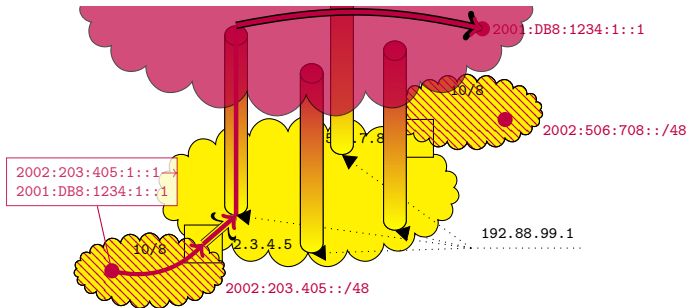

- Cannot cross NAT (need to know public address)
- Bad performances.

- based on the magic formula $16+32=48$
 - $2002::/16 + \text{IPv4 address}$

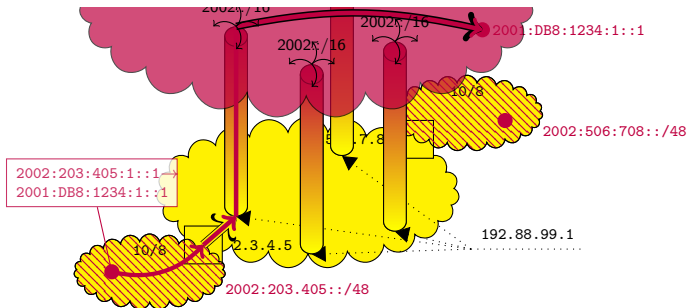

- Cannot cross NAT (need to know public address)
- Bad performances.

- based on the magic formula $16+32=48$
 - $2002::/16 + \text{IPv4 address}$

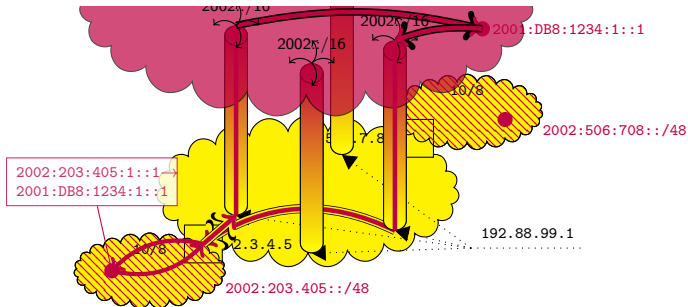

- Cannot cross NAT (need to know public address)
- Bad performances.

- based on the magic formula $16+32=48$
- $2002::/16$ + IPv4 address

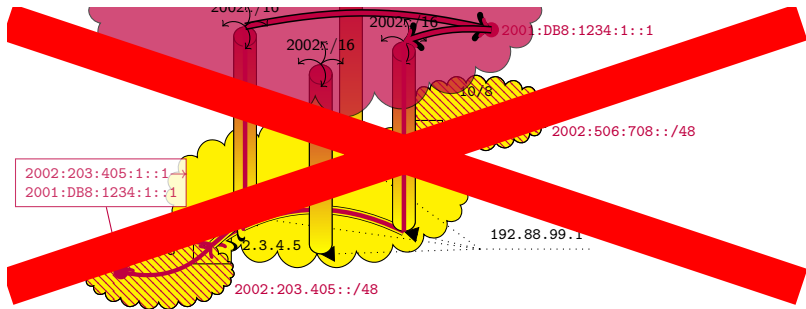

- Cannot cross NAT (need to know public address)
- Bad performances.

- Integration
- Why IPv6
- Integration ?
- 6 generic scenarios
- Tools overview
- Scenarios
- Backbone operator
- Internet Access Provider
- 3G/LTE
- Enterprise
- Home network and SOHO
- Programming IPv6
- Applications

- Based on NAT Traversal protocol
- 2001::/32 allocated to this mechanism.

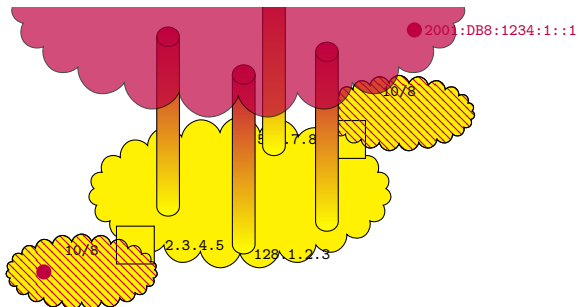

Integration

Why IPv6

Integration ?

6 generic scenarios

Tools overview

Scenarios

Backbone operator

Internet Access Provider

3G/LTE

Enterprise

Home network and SOHO

Programming

IPv6

Applications

- Based on NAT Traversal protocol
- 2001::/32 allocated to this mechanism.

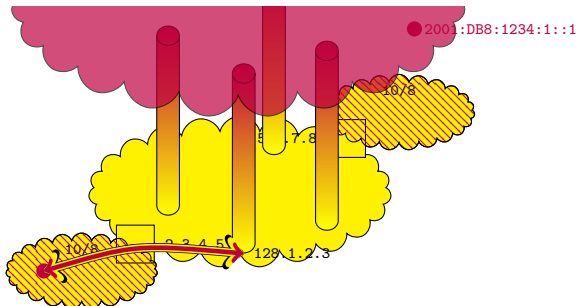

- Based on NAT Traversal protocol
- 2001::/32 allocated to this mechanism.

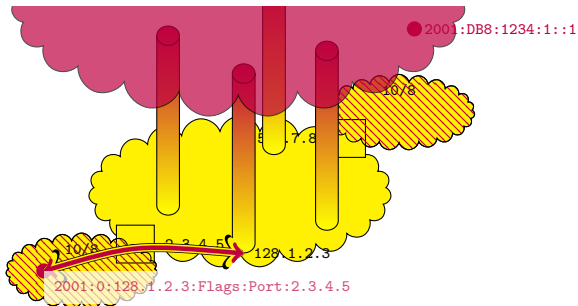

Integration

Why IPv6
Integration ?
6 generic scenarios

Tools overview
Scenarios
Backbone operator
Internet Access Provider
3G/LTE
Enterprise
Home network and SOHO

Programming IPv6
Applications

- Based on NAT Traversal protocol
- 2001::/32 allocated to this mechanism.

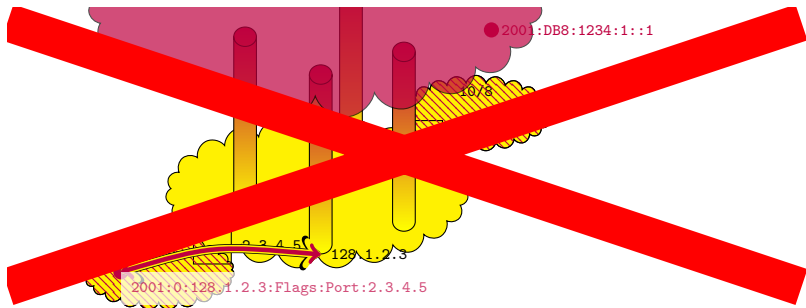

Integration

Why IPv6

Integration ?

6 generic scenarios

Tools overview

Scenarios

Backbone operator

Internet Access Provider

3G/LTE

Enterprise

Home network and SOHO

Programming

IPv6

Applications

- If performances with 6to4 and TEREDO are worst than with IPv4
- What happens if a site decides to activate dual stack on its servers ?
 - Customers will run away
- if IPv6 is dead
 - client starts with IPv6 and then after a long timeout tries IPv4
 - bad performances
- Happy Eyes Ball: try IPv4 and IPv6 simultaneously
- Test the same day IPv6 on main sites
 - Customer will not run away

- the 6/8/11: World IPv6 Day
 - Good news: nobody notice it
 - 0.3% of IPv6 traffic
- Conclusion: Activating IPv6 do not create troubles
- 6/6/12: World IPv6 Launch day on main sites (google, yahoo, facebook, akamai, . . .)
 - Potentially 50% of Internet traffic
 - in reality less since access network is missing



Integration

Programming

IPv6

Applications

CC++ API

JAVA API

IPv6 socket API in C, C++

Integration

Programming

IPv6

Applications

CC++ API

JAVA API

- Socket Unix API has been extended to IPv6
- New protocol and address family PF_INET6 and AF_INET6
- New structures :
 - in6_addr
 - sockaddr_in6
 - sockaddr_storage
- New functions for names to addresses conversion

Reference

[RFC 3493](#) & Posix 1003.1g

Structure in C, C++

```
struct sockaddr_in6 {  
    uint8_t        sin6_len;        /* structure length  
    sa_family_t    sin6_family;     /* AF_INET6  
    in_port_t      sin6_port;       /* transport layer port  
    uint32_t       sin6_flowinfo;   /* IPv6 traffic class & flow info  
    struct in6_addr sin6_addr;      /* IPv6 address  
    uint32_t       sin6_scope_id;   /* set of interfaces for a scope  
};
```

- Similar to sockaddr_in for IPv4
- New fields for scope and flow label

Structure in C, C++

```
struct sockaddr_in6 {  
    uint8_t        sin6_len;        /* structure length  
    sa_family_t    sin6_family;     /* AF_INET6  
    in_port_t      sin6_port;       /* transport layer port  
    uint32_t       sin6_flowinfo;   /* IPv6 traffic class & flow info  
    struct in6_addr sin6_addr;      /* IPv6 address  
    uint32_t       sin6_scope_id;   /* set of interfaces for a scope  
};
```

- Similar to `sockaddr_in` for IPv4
- New fields for scope and flow label

`sizeof(sockaddr_in6) > sizeof(sockaddr_in)`

- `sockaddr_in6` can not be stored in `struct sockaddr`
- Programs have to be modified to be AF-independent !

Integration

Programming

IPv6

Applications

CC++ API

JAVA API

Managing Sockets in C, C++

Integration

Programming

IPv6

Applications

CC++ API

JAVA API

- Creation : Same as in IPv4
 - `int s = socket(PF_INET6, SOCK_STREAM, 0);`
- Other functions are not modified
 - `bind, connect, listen, accept, send*, recv*, getpeername, getsockname`
- New functions to manage options
 - `getsockopt, setsockopt`

2 options for applications :

- Only use PF_INET6 socket
 - On a IPv4 networks, use IPv4-mapped IPv6 addresses
 - **Problem: when IPv6 stack is not available ...**
- Use one PF_INET socket and one PF_INET6 socket
 - Client knows which socket to open with getaddrinfo
 - Server should wait for packets on both sockets

Examples found with `netstat -taun` (MacOSX)

```
Proto Rec Send Local Foreign State
tcp46 0 0 *.80 *.* LISTEN ← Apache server uses first option
...
tcp4 0 0 *.22 *.* LISTEN ← SSH server uses second option
tcp6 0 0 *.22 *.* LISTEN ←
```

Integration

Programming

IPv6

Applications

CC++ API

JAVA API

```
#include <stdio.h>
#include <unistd.h>
#include <sys/socket.h>
#include <netdb.h>

int open_conn(const char *host) {
    int sock = -1, ecode;
    struct addrinfo *res, *r, hints = {
        0, PF_UNSPEC, SOCK_STREAM, 0};

    if ((ecode = getaddrinfo(host, "daytime", &hints, &res))
        errx(1, "getaddrinfo: %s", gai_strerror(ecode));
    for (r = res; r && sock < 0; r = res->ai_next)
        if ((sock = socket(res->ai_family, res->ai_socktype, res->ai_protocol)) < 0 ||
            connect(sock, res->ai_addr, res->ai_addrlen))
            sock = -1;
    freeaddrinfo(res);
    return sock;
}
```

Integration

Programming

IPv6

Applications

CC++ API

JAVA API

```
#include <stdio.h>
#include <unistd.h>
#include <sys/socket.h>
#include <netdb.h>

int open_serv(const char *serv) {
    int sock, ecode;
    struct addrinfo *res, hints = {
        AI_PASSIVE, PF_UNSPEC, SOCK_STREAM, 0};

    if ((ecode = getaddrinfo(NULL, serv, &hints, &res))
        errx(1, "getaddrinfo: %s", gai_strerror(ecode));
    if ((sock = socket(res->ai_family, res->ai_socktype, res->ai_protocol)) < 0) ||
        bind(sock, res->ai_addr, res->ai_addrlen) ||
        listen(sock, 1))
        err(1, "socket");
    freeaddrinfo(res);
    return sock;
}
```

Integration

Programming

IPv6

Applications

CC++ API

JAVA API

```
main() {
    int sock = open_serv("1000");

    for(;;) {
        struct sockaddr_storage from;
        int s, len = sizeof from;
        char name[NI_MAXHOST];

        if ((s = accept (sock, (struct sockaddr*)&from, &len) < 0)
            err(1, "accept");

        if (getnameinfo((struct sockaddr*)&from, &len, name,
            sizeof name, NULL, 0, NI_NUMERICHOST))
            name[0] = 0;
        printf("connexion %s\n", name);
        /* utiliser socket s ? */
        close (s);
    }
}
```

Integration

Programming

IPv6

Applications

CC++ API

JAVA API

Rules to anticipate integration of IPv6 protocol

- Programs should use struct `sockaddr_storage` to be AF-independent
- Cast depending of AF when needed

Socket containers

```
struct sockaddr_storage ss;
foo((struct sockaddr *)&ss);    // AF independent function

void foo(struct sockaddr *s) {
    // If we need IPv4 socket
    struct sockaddr_in *sin = (struct sockaddr_in *) s;
    // If we need IPv6 socket
    struct sockaddr_in6 *sin6 = (struct sockaddr_in6 *) s;
}
```

Reference

`socket(7)`

getaddrinfo() Prototype

```
int getaddrinfo(const char *nodename,  
               const char *servname,  
               const struct addrinfo *hints,  
               struct addrinfo **res);
```

- Generic function for name resolution, AF-independent
- Replace function gethostbyname
- servname: String for protocol name ("http") or port number ("80")
- hints: Refine request (IPv4 only, IPv6 only, IPv4/IPv6)
- **May return more than one result !**

Reference

getaddrinfo(3)

getnameinfo() Prototype

```
int getnameinfo(const struct sockaddr *sa,  
                socklen_t salen,  
                char *host,  
                socklen_t hostlen,  
                char *serv, socklen_t servlen,  
                int flags);
```

- Generic function for reverse resolution, AF-independent
- Replace function gethostbyaddr

Reference

getnameinfo(3)

Integration

Programming

IPv6

Applications

CC++ API

JAVA API

Macros to test nature of address:

- `IN6_IS_ADDR_UNSPECIFIED (struct in6_addr *)`;
- `IN6_IS_ADDR_LOOPBACK (struct in6_addr *)`;
- `IN6_IS_ADDR_MULTICAST (struct in6_addr *)`;
- `IN6_IS_ADDR_LINKLOCAL (struct in6_addr *)`;

Macros to test address equality :

- `IN6_ARE_ADDR_EQUAL (struct in6_addr *, struct in6_addr *)`;

Integration

Programming

IPv6

Applications

CC++ API

JAVA API

Migrate existing applications

- 1: Replace IPv4-only structures and functions with AF-independent version

Generic Structure & Functions

```
hostent → addrinfo  
sockaddr_in → sockaddr_storage  
gethostbyname → getaddrinfo  
gethostbyaddr → getnameinfo
```

- 2: Look for particular usage of IP address structure `in_addr`
 - Applications sometimes use IP addresses as host identifier
 - This should be made AF-independent

- 3: Choose a strategy when opening socket (one or two sockets ?)
- 4: Consider one host may have more than one address !
 - With `getaddrinfo` you may have one IPv4 and several IPv6 addresses for one host
 - To be also considered when using address as host identifier
- 5: Beware of textual representation of IP addresses

Beware

```
http://[2001:660:7301:1::1]  
scp foo.bar [2001:660:7301:1::1]:/tmp
```

Integration

Programming

IPv6

Applications

CC++ API

JAVA API

IPv6 JAVA API

Integration

Programming

IPv6

Applications

CC++ API

JAVA API

- Java support IPv6 since JDK 1.2, extended with JDK 1.4
- Extension have been made for class `InetAddress`
- Inheritance and polymorphism ensures relative transparency for version of manipulated addresses

Integration

Programming

IPv6

Applications

CC++ API

JAVA API

New subclass of InetAddress (with Inet4Address)

- Class for instantiate IPv6 addresses
- Methods for checking address scope :
 - `isIPv4CompatibleAddress` (for IPv4-mapped addresses)
 - `isLinkLocalAddress`
 - `isMulticastAddress`

InetAddress objects may be either IPv4 or IPv6 address
InetAddress class extended for DNS resolution

- Method `getByName` returns only IPv4 name resolution
- New method `getAllByName` returns all possible name resolutions (IPv4 and IPv6)
- Reverse resolution unchanged

Changes for IPv6 support

Name resolution using `getByName` should be changed to use `getAllByName` and uses the returned array of addresses

- Socket API is based on super-class InetAddress → no major change
- By choosing binding address, change protocol enabled for socket
 - IPv4 binding address → Socket listening for IPv4
 - IPv6 binding address → Socket listening for IPv4 and IPv6

Consequences

- Integration of IPv6 is harmless for IPv4 operations
- IPv6 will be used when correspondent address is IPv6